



▼ series

▼ page

Swing cylinder range overview		22 - 23	
Upper flange swing clamps	SU	24 - 25	
Lower flange swing clamps	SL	26 - 27	
Threaded body swing clamps	ST	28 - 29	
Cartridge model swing clamps	SC	30 - 31	
Clamp arms	CA	32 - 33	
Pivoting T-arms	CAC CAPT	34 - 35	
Upreach clamp arms	CAU	36 - 37	
Swing clamps	SC	38	
Swing clamps	ASC	39	
Three-position swing clamps	WTR	40 - 41	

Swing clamps *Application & selection*

Shown: SCRD-122, STLD-21, SLRS-201

Collet-Lok® product line
Swing clamps



Compact and full featured design

- Compact design allows for efficient fixture layout
- Variety of mounting styles to meet design needs
- Double and single-acting cylinders to suit a variety of hydraulic requirements
- Choice of porting styles to meet system and design requirements
- All cylinders are available as left and right turning models
- Large ball and cam design on 21, 51 and 121 models allows swing rotation to be changed easily
- Overload clutch mechanism on 92, 201, and 351 models prevents damage to cylinder from high flow rates or misapplication

▶ Enerpac swing clamps allow unobstructed part fixturing and placement. The plunger rod and the attached clamp arm rotate 90 degrees in either a clockwise or counter-clockwise direction, then travel down an additional distance to clamp against the fixtured part. Upon release of clamping pressure, the clamp arm rotates back 90 degrees in the opposite direction to allow for part removal and new part placement.

Roller in groove

- Double index provides low height design to minimize fixture height
- Overload clutch allows clamp to disengage if needed to prevent damage due to improper part loading

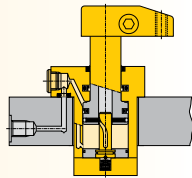

Ball in groove

- Rotation direction can be changed on-site to reduce spare inventory by 2/3 (67%)
- Ball and cam rotation ensures smooth accurate operation

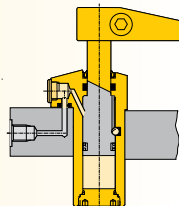

■ *Swing clamps used in conjunction with work supports and other Enerpac components to positively hold the workpieces during machining operations.*

i Select your swing cylinder type:

Single acting

- The obvious choice when there are few system restrictions, and there are not many units retracting simultaneously
- Fewer valving requirements which results in a less complex circuit
- Innovative clamp arm design allows quick and secure arm positioning

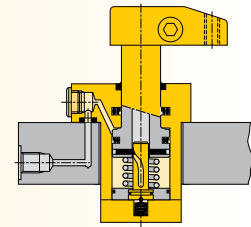

Double acting

- Used when greater control is required during the unclamp cycle
- When timing sequences are critical: less sensitive to system back pressures, resulting from long tube lengths or numerous components being retracted at the same time
- Innovative clamp arm design allows quick and secure arm positioning

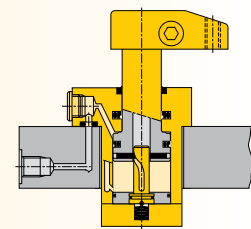

For Collet-Lok® positive locking swing clamps, see □ 12 ▶

Select your mounting method:

SU series, Upper flange mounting

- Flexible design allows for manifold or threaded oil port connection
- Fixture hole does not require tight tolerances
- Easy installation with only 3 or 4 mounting bolts

 24 ▶

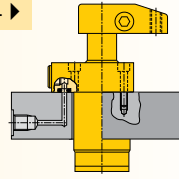

SL series, Lower flange mounting

- Flexible design allows for manifold or threaded port connection
- No fixture hole required
- Easy installation with only 3 or 4 mounting bolts

 26 ▶

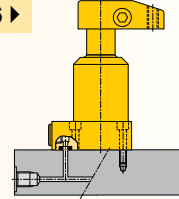

ST series, Threaded body mounting

- Body thread for precise cylinder height positioning
- Threaded oil port connection
- Can be threaded directly into the fixture and secured in position by means of standard flange nuts

 28 ▶

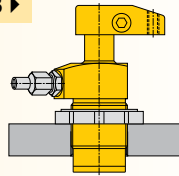



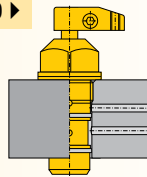

SC series, Cartridge mounting

- Minimal space required on fixture
- External plumbing not required
- Allows close positioning of adjoining units
- Cylinder can be completely recessed in fixture

 30 ▶

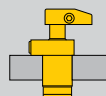

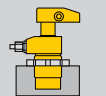
Product selection

Clamping force ¹⁾	Stroke		Upper flange	Lower flange	Threaded body	Cartridge
	in					
lbs	clamping	total				
▼ Single acting						
			Model number ²⁾			
475	.32	.65	SURS-21	SLRS-21	STRS-21	SCRS-22
1100	.39	.89	SURS-51	SLRS-51	STRS-51	SCRS-52
1800	.47	.90	SURS-92	SLRS-92	STRS-92	-
2400	.50	1.10	SURS-121	SLRS-121	STRS-121	SCRS-122
3900	.55	1.16	SURS-201	SLRS-201	STRS-201	-
7450	.63	1.28	SURS-351	SLRS-351	STRS-351	-
▼ Double acting						
			Model number ²⁾			
500	.32	.65	SURD-21	SLRD-21	STRD-21	SCRD-22
1250	.39	.89	SURD-51	SLRD-51	STRD-51	SCRD-52
2025	.47	.90	SURD-92	SLRD-92	STRD-92	-
2025	1.26	1.69	SURDL-92*	-	-	-
2600	.50	1.10	SURD-121	SLRD-121	STRD-121	SCRD-122
2600	1.25	1.85	SURDL-121	-	-	-
4200	.55	1.16	SURD-201	SLRD-201	STRD-201	-
7600	.63	1.28	SURD-351	SLRD-351	STRD-351	-
7600	1.25	1.91	SURDL-351*	-	-	-



¹⁾ With standard clamp arm. Clamp arms are sold separately ( 32). Clamping forces for single-acting models are reduced in order to overcome return spring force. ²⁾ For left turning swing clamps replace the R in the model number for an L. **Note:** Call Enerpac to order models with metric thread and BSPP port connections.

* This product is made to order. Please contact Enerpac for delivery information before specifying in your design.

Force: 475 - 7600 lbs

Stroke: .65 - 1.91 inch

Pressure: 500 - 5000 psi

-  Cilindros giratorios
-  Vérins de bridage pivotants
-  Schwenkspannzylinder

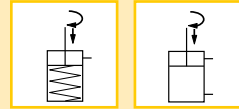

Options

Available as both left and right turning

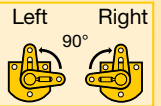

Clamp arms

 32 ▶



Work supports

 43 ▶



Accessories

 86 ▶



Important

Actual clamping may only take place when the cylinder has completed its 90° swing.

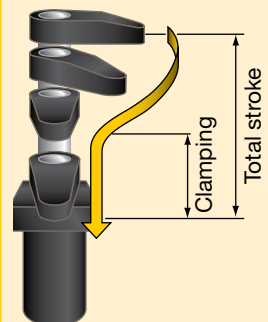

All swing clamps have swing angle repeatability of $\pm 1^\circ$.

Other swing angles available upon request.

Contact Enerpac for info.

Swing clamps - Upper flange model

Shown: SURS-51, SURS-201



SU series

The Enerpac upper flange swing clamps are designed for integrated manifold mounting solutions. Hydraulic connections are made through SAE or BSPP oil connection or the standard integrated O-ring ports.

SAE oil connection

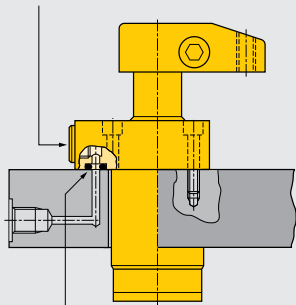

Integrated O-ring port

■ Enerpac upper flange swing clamps integrated into a fully automated machining system.



Minimal mounting height

...when space is at a premium

- Flexible design allows for manifold or threaded port connection
- Low profile mounting style allows body to be below mounting surface
- Simple mounting preparation and easy installation – 3 or 4 mounting bolts
- Double oil connection – threaded port or manifold mount
- Symmetrical rectangular flange design enables clamping at three sides of the cylinder
- 30, 45, and 60 degree swing angles available on request

Product selection

Clamping force ¹⁾	Stroke		Left turning 90°	Right turning 90°	Cylinder effective area		Oil capacity		Max. oil flow ¹⁾	Standard clamp arm Sold separately □ 32 ▶
	lbs	Clamp			in	Total	in ²	in ³		
▼ Single acting										
Model number ²⁾										
475	.32	.65	SULS-21	SURS-21	.12	–	.08	–	12	CAS-21
1100	.39	.89	SULS-51	SURS-51	.28	–	.25	–	25	CAS-51
1800	.47	.90	SULS-92	SURS-92	.49	–	.42	–	60	CAS-92
2400	.50	1.10	SULS-121	SURS-121	.63	–	.70	–	100	CAS-121
3900	.55	1.16	SULS-201	SURS-201	1.10	–	1.22	–	140	CAS-201
7450	.63	1.28	SULS-351	SURS-351	1.92	–	2.27	–	240	CAS-351
▼ Double acting										
Model number ²⁾										
500	.32	.65	SULD-21	SURD-21	.12	.24	.08	.16	12	CAS-21
1250	.39	.89	SULD-51	SURD-51	.28	.59	.25	.53	25	CAS-51
2025	.47	.90	SULD-92	SURD-92	.49	1.25	.42	1.08	60	CAS-92
2025	1.26	1.69	SULDL-92*	SURDL-92*	.49	1.25	.81	1.86	60	CAS-92
2600	.50	1.10	SULD-121	SURD-121	.63	1.23	.70	1.40	100	CAS-121
2600	1.25	1.85	SULDL-121	SURDL-121	.63	1.23	.97	2.30	100	CAS-121
4200	.55	1.16	SULD-201	SURD-201	1.10	2.35	1.22	2.60	140	CAS-201
7600	.63	1.28	SULD-351	SURD-351	1.92	3.68	2.27	4.35	240	CAS-351
7600	1.25	1.91	SULDL-351*	SURDL-351*	1.92	3.68	3.53	6.77	240	CAS-351

¹⁾ With standard clamp arm. Clamp arms are sold separately (□ 32). Clamping forces for single-acting models are reduced in order to overcome return spring force.

²⁾ For models with straight plunger movement, replace L or R with S.

* This product is made to order. Please contact Enerpac for delivery information before specifying in your design.

Note: Call Enerpac to order models with BSPP port connections.

Dimensions in inches [⊜]

Left turning models	A	B	C	C1	D	D1	D2	F	G	H	K	M
						∅				∅		
▼ Single acting												
SULS-21	4.41	2.32	1.05	1.69	1.10	1.86	1.77	0.39	SAE #2	0.43	0.63	–
SULS-51	5.33	2.73	1.08	1.97	1.37	2.13	2.25	0.63	SAE #4	0.38	0.76	–
SULS-92	5.68	3.00	1.11	2.02	1.88	2.76	2.13	0.98	G1/4"	0.51	0.99	0.59
SULS-121	6.75	3.37	1.08	2.18	1.87	2.62	2.88	0.87	SAE #4	0.39	1.20	–
SULS-201	6.57	3.47	1.12	2.28	2.46	3.35	2.76	1.26	SAE #4	0.51	1.19	0.91
SULS-351	7.45	3.96	1.11	2.39	3.02	3.94	3.50	1.50	SAE #4	0.51	1.58	1.08
▼ Double acting												
SULD-21	4.41	2.32	1.05	1.69	1.10	1.86	1.77	0.39	SAE #2	0.43	0.63	–
SULD-51	5.33	2.73	1.08	1.97	1.37	2.13	2.25	0.63	SAE #4	0.38	0.76	–
SULD-92	5.68	3.00	1.11	2.02	1.88	2.76	2.13	0.98	G1/4"	0.51	0.99	–
SULDL-92*	7.25	3.79	1.11	2.80	1.88	2.76	2.13	0.98	G1/4"	0.51	0.99	–
SULD-121	6.75	3.37	1.08	2.18	1.87	2.62	2.88	0.87	SAE #4	0.39	1.20	–
SULDL-121	9.00	4.12	1.08	2.93	1.87	2.62	2.88	0.87	SAE #4	0.39	1.20	–
SULD-201	6.57	3.47	1.12	2.28	2.46	3.35	2.76	1.26	SAE #4	0.51	1.19	–
SULD-351	7.45	3.96	1.11	2.39	3.02	3.94	3.50	1.50	SAE #4	0.51	1.58	–
SULDL-351*	8.70	4.59	1.11	3.01	3.02	3.94	3.50	1.50	SAE #4	0.51	1.58	–

NOTE: dimensions shown with standard clamp arm.

* This product is made to order. Please contact Enerpac for delivery information before specifying in your design.

Installation dimensions in inches

Clamping force ¹⁾ lbs	Fixture hole Ø D3	Mounting thread J UNF	Min. depth J2	Manifold O-ring ²⁾ ARP number or inside Ø x thickness
500	1.110	#10-32	.65	568-010
1250	1.380	.250-28	.65	568-011
2025	1.895	M6	.59	.17 x .139
2600	1.880	.312-24	.80	568-011
4200	2.475	.312-24	.67	.17 x .139
7600	3.035	.375-24	.74	.17 x .139

¹⁾ With standard clamp arm.
²⁾ Polyurethane, 92 Durometer

Note: Mounting bolts and O-rings included.

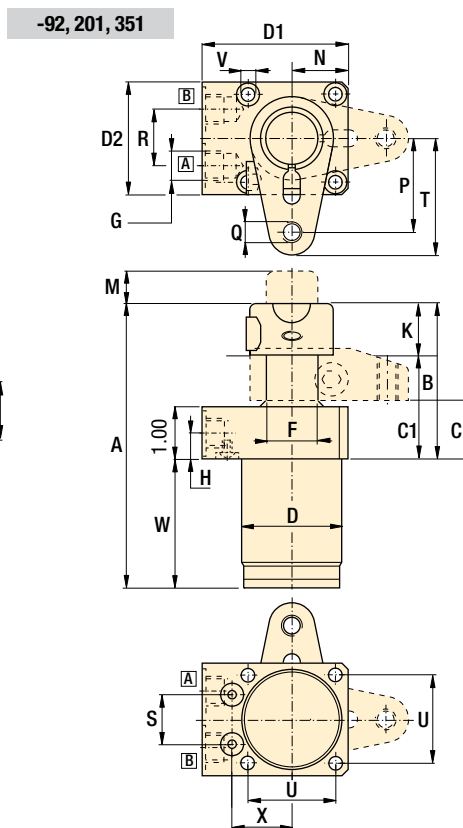
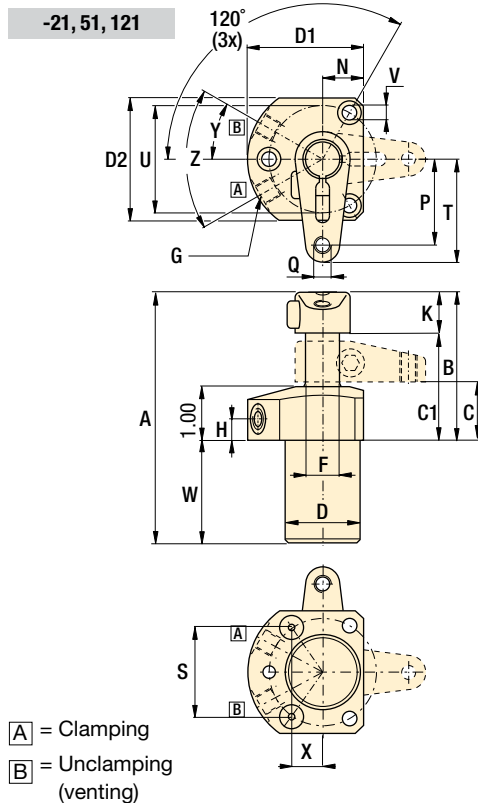
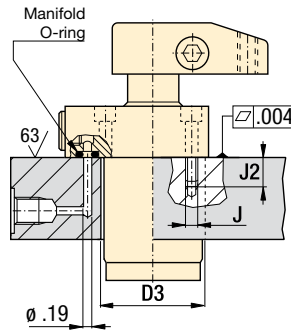

N	P	Q	R	S	T	U	V	W	X	Y	Z	Right turning models lbs
Single acting ▼												
0.61	0.97	.250-20 UNC	-	0.825	1.22	Ø1.58	0.225	2.09	0.714	30°	60°	1.0 SURS-21
0.75	1.58	.312-18 UNC	-	1.614	1.89	Ø1.97	0.268	2.6	0.565	30°	60°	2.5 SURS-51
1.04	1.78	M10 X 1,5	1.02	0.934	2.21	1.65	0.256	2.67	1.128	-	-	4.4 SURS-92
0.99	2.00	.375-16 UNC	-	2.048	2.44	Ø2.50	0.347	3.38	0.717	30°	60°	3.5 SURS-121
1.35	2.18	.500-13 UNC	1.02	1.145	2.77	2.17	0.335	3.11	1.382	-	-	7.7 SURS-201
1.71	2.68	.625-11 UNC	1.02	1.356	3.27	2.76	0.425	3.49	1.637	-	-	12.1 SURS-351
Double acting ▼												
0.61	0.97	.250-20 UNC	-	0.825	1.22	Ø1.58	0.225	2.09	0.714	30°	60°	1.0 SURD-21
0.75	1.58	.312-18 UNC	-	1.614	1.89	Ø1.97	0.268	2.6	0.565	30°	60°	2.5 SURD-51
1.04	1.78	M10 X 1,5	1.02	0.934	2.21	1.65	0.256	2.67	1.128	-	-	4.4 SURD-92
1.04	1.78	M10 X 1,5	1.02	0.934	2.21	1.65	0.256	2.67	1.128	-	-	5.7 SURDL-92*
0.99	2.00	.375-16 UNC	-	2.048	2.44	Ø2.50	0.347	3.38	0.717	30°	60°	3.5 SURD-121
0.99	2.00	.375-16 UNC	-	2.048	2.44	Ø2.50	0.347	3.38	0.717	30°	60°	4.0 SURDL-121
1.35	2.18	.500-13 UNC	1.02	1.145	2.77	2.17	0.335	3.11	1.382	-	-	7.7 SURD-201
1.71	2.68	.625-11 UNC	1.02	1.356	3.27	2.76	0.425	3.49	1.637	-	-	12.1 SURD-351
1.71	2.68	.625-11 UNC	1.02	1.356	3.27	2.76	0.425	3.49	1.637	-	-	15.1 SURDL-351*

- Force: 475 - 7600 lbs
- Stroke: .65 - 1.91 inch
- Pressure: 500 - 5000 psi

- E** Cilindros giratorios
- F** Vérins de bridage pivotants
- D** Schwenkspannzylinder

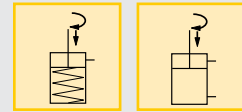

Options

- Clamp arms 32 ▶
- Work supports 43 ▶
- Collet-Lok® swing cylinders 12 ▶
- Accessories 86 ▶

Important

30, 45, and 60 degree rotations are available upon request. Add -30, -45 or -60 to end of standard model number to order directly from Enerpac. To order rotation limiter separately, see page 58.

Custom cylinders including longer stroke lengths are available on request.

In case there is a risk of machining coolants and debris being inhaled via the breather vent, it is recommended to pipe this port to an area outside the fixture that is protected from machining coolants and debris.

Do not exceed maximum flow rates.

Swing clamps - Lower flange models

Shown: SLRD-51, SLRS-201



SL series

Enerpac lower flange series swing clamps can be bolted to the fixture, allowing easy installation of the unit and does not require machined fixture holes. Hydraulic connections are made through SAE or BSPP oil connection or the standard integrated O-ring ports.

SAE oil connection

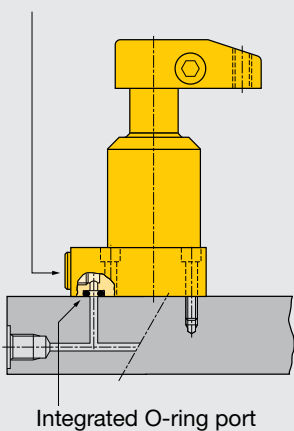

Lower flange swing clamps mounted to the face of the fixture.



No fixture hole required

...cylinder can be bolted directly to fixture

- Flexible design allows for manifold or threaded port connection
- No fixture hole preparation required
- Easiest mounting preparation in the swing cylinder line
- Symmetrical rectangular flange design enables clamping at three sides of the cylinder
- Allows extra large parts to be clamped
- 30, 45 and 60 degree swing angles available on request

Product selection

Clamping force ¹⁾	Stroke		Left turning 90°	Right turning 90°	Cylinder effective area		Oil capacity		Max. oil flow ¹⁾	Standard clamp arm Sold separately 32 ▶
	lbs	Clamp			Total	in ²	in ³	Un-clamp		
▼ Single acting										
Model number ²⁾										
475	.32	.65	SLLS-21	SLRS-21	.12	–	.08	–	12	CAS-21
1100	.39	.89	SLLS-51	SLRS-51	.28	–	.25	–	25	CAS-51
1800	.47	.90	SLLS-92	SLRS-92	.49	–	.42	–	60	CAS-92
2400	.50	1.10	SLLS-121	SLRS-121	.63	–	.70	–	100	CAS-121
3900	.55	1.16	SLLS-201	SLRS-201	1.10	–	1.22	–	140	CAS-201
7450	.63	1.28	SLLS-351	SLRS-351	1.92	–	2.27	–	240	CAS-351
▼ Double acting										
Model number ²⁾										
500	.32	.65	SLLD-21	SLRD-21	.12	.24	.08	.15	12	CAS-21
1250	.39	.89	SLLD-51	SLRD-51	.28	.59	.25	.52	25	CAS-51
2025	.47	.90	SLLD-92	SLRD-92	.49	1.25	.42	1.08	60	CAS-92
2600	.50	1.10	SLLD-121	SLRD-121	.63	1.23	.70	1.40	100	CAS-121
4200	.55	1.16	SLLD-201	SLRD-201	1.10	2.35	1.22	2.60	140	CAS-201
7600	.63	1.28	SLLD-351	SLRD-351	1.92	3.68	2.27	4.35	240	CAS-351

¹⁾ With standard clamp arm. Clamp arms are sold separately (page 32). Clamping forces for single-acting models are reduced in order to overcome return spring force.»

²⁾ For models with straight plunger movement, replace L or R with S.

Note: Call Enerpac to order models with BSPP port connections.

Dimensions in inches []

Left turning models	A	C	C1	D	D1	D2	F	G	H	K	M
	ø										
▼ Single acting											
SLLS-21	4.41	3.13	3.78	1.10	1.86	1.77	0.39	SAE #2	0.54	0.63	–
SLLS-51	5.33	3.68	4.57	1.37	2.13	2.25	0.63	SAE #4	0.55	0.76	–
SLLS-92	5.99	4.10	5.01	1.88	2.76	2.13	0.98	G1/4"	0.49	0.99	0.59
SLLS-121	6.75	4.46	5.56	1.87	2.62	2.88	0.87	SAE #4	0.61	1.2	–
SLLS-201	6.89	4.54	5.70	2.51	3.35	2.76	1.26	SAE #4	0.49	1.19	0.91
SLLS-351	7.77	4.91	6.19	3.14	3.94	3.50	1.50	SAE #4	0.49	1.58	1.08
▼ Double acting											
SLLD-21	4.41	3.13	3.78	1.10	1.86	1.77	0.39	SAE #2	0.54	0.63	–
SLLD-51	5.33	3.68	4.57	1.37	2.13	2.25	0.63	SAE #4	0.55	0.76	–
SLLD-92	5.99	4.10	5.01	1.88	2.76	2.13	0.98	G1/4"	0.49	0.99	–
SLLD-121	6.75	4.46	5.56	1.87	2.62	2.88	0.87	SAE #4	0.61	1.2	–
SLLD-201	6.89	4.54	5.70	2.51	3.35	2.76	1.26	SAE #4	0.49	1.19	–
SLLD-351	7.77	4.91	6.19	3.14	3.94	3.50	1.50	SAE #4	0.49	1.58	–

NOTE: dimensions shown with standard clamp arm.

Installation dimensions in inches

Clamping force ¹⁾ lbs	Mounting thread J	Minimum thread depth J2	Manifold O-ring ²⁾ ARP number or inside Ø x thickness
500	#10-32	.65	568-010
1250	.250-28	.65	568-011
2025	M6	.59	.17 x .139
2600	.312-24	.80	568-011
4200	.312-24	.67	.17 x .139
7600	.375-24	.74	.17 x .139

¹⁾ With standard clamp arm.
²⁾ Polyurethane, 92 Durometer

Note: Mounting bolts and O-rings included.

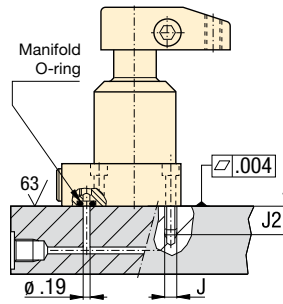

-21, 51, 121

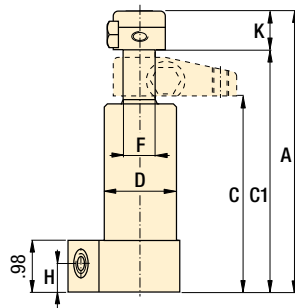
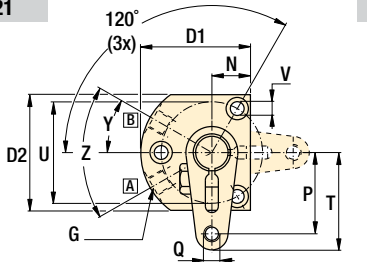

A = Clamping
B = Unclamping (venting)

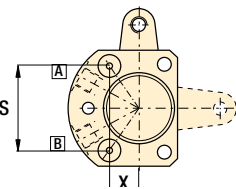

-92, 201, 351

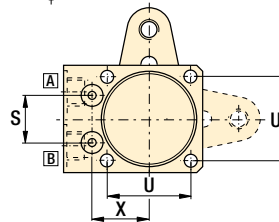
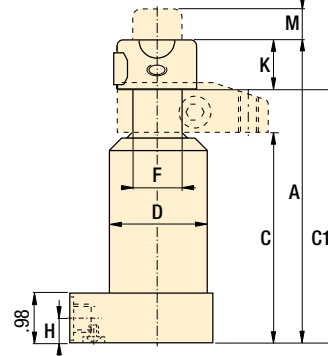
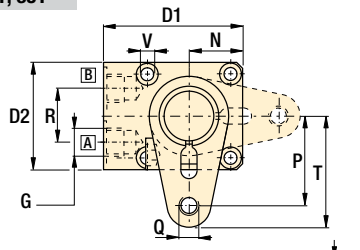

- Force: 475 - 7600 lbs
- Stroke: .65 - 1.28 inch
- Pressure: 500 - 5000 psi

- E** Cilindros giratorios
- F** Vérins de bridage pivotants
- D** Schwenkspannzylinder

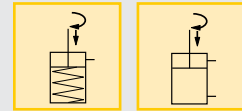

Options

- Clamp arms** 32 ▶
- Work supports** 43 ▶
- Collet-Lok® swing cylinders** 12 ▶
- Accessories** 86 ▶

Important

30, 45, and 60 degree rotations are available upon request. Add -30, -45 or -60 to end of standard model number to order directly from Enerpac. To order rotation limiter separately, see page 32.

Custom cylinders including longer stroke lengths are available on request.

In case there is a risk of machining coolants and debris being inhaled via the breather vent, it is recommended to pipe this port to an area outside the fixture that is protected from machining coolants and debris.

Do not exceed maximum flow rates.

	N	P	Q	R	S	T	U	V	X	Y	Z	Right turning models
			UN				ø					lbs
												Single acting ▼
	0.61	0.97	.250-20 UNC	-	0.825	1.22	1.58	0.23	0.714	30°	60°	1.0 SLRS-21
	0.75	1.58	.312-18 UNC	-	1.614	1.89	1.97	0.27	0.565	30°	60°	2.5 SLRS-51
	1.04	1.78	M10 x 1,5	1.02	0.934	2.21	1.65	0.26	1.128	-	-	4.4 SLRS-92
	0.99	2.03	.375-16 UNC	-	2.048	2.44	2.5	0.35	0.717	30°	60°	3.5 SLRS-121
	1.35	2.18	.500-13 UNC	1.02	1.145	2.77	2.17	0.33	1.382	-	-	7.7 SLRS-201
	1.71	2.68	.625-11 UNC	1.02	1.356	3.27	2.76	0.43	1.637	-	-	12.1 SLRS-351
												Double acting ▼
	0.61	0.97	.250-20 UNC	-	0.825	1.22	1.58	0.23	0.714	30°	60°	1.0 SLRD-21
	0.75	1.58	.312-18 UNC	-	1.614	1.89	1.97	0.27	0.565	30°	60°	2.5 SLRD-51
	1.04	1.78	M10 x 1,5	1.02	0.934	2.21	1.65	0.26	1.128	-	-	4.4 SLRD-92
	0.99	2.03	.375-16 UNC	-	2.048	2.44	2.5	0.35	0.717	30°	60°	3.5 SLRD-121
	1.35	2.18	.500-13 UNC	1.02	1.145	2.77	2.17	0.33	1.382	-	-	7.7 SLRD-201
	1.71	2.68	.625-11 UNC	1.02	1.356	3.27	2.76	0.43	1.637	-	-	12.1 SLRD-351

Swing clamps

Work supports

Linear cylinders

Power sources

Valves

Pallet components

System components

Yellow pages

Swing clamps - Threaded body models

Shown: STRD-51, STRD-201



ST series

Enerpac threaded body swing clamps are threaded directly into the fixture.

The cylinder height is adjusted to the appropriate height, and then locked in place using a jam nut (□32).

SAE oil connection

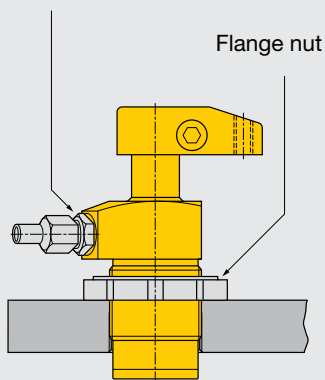

Threaded body swing clamps allow the clamp to be buried in the fixture to minimize the required area, while the height remains adjustable.



Cylinders can be threaded directly into fixture

...can be secured at any height

- Body thread for precise cylinder height positioning
- Threaded port connection
- Easy installation and removal
- Greatest flexibility in fixture design
- 30, 45 and 60 degree swing angles available on request

Product selection

Clamping force ¹⁾	Stroke		Left turning 90°	Right turning 90°	Cylinder effective area		Oil capacity		Max. oil flow ¹⁾	Standard clamp arm
	lbs	Clamp			Total	in ²	in ³	in ³ /min		
▼ Single acting										
Model number ²⁾										
475	.32	.65	STLS-21	STRS-21	.12	–	.08	–	12	CAS-21
1100	.39	.89	STLS-51	STRS-51	.28	–	.25	–	25	CAS-51
1800	.47	.90	STLS-92	STRS-92	.49	–	.42	–	60	CAS-92
2400	.50	1.09	STLS-121	STRS-121	.63	–	.70	–	100	CAS-121
3900	.55	1.16	STLS-201	STRS-201	1.10	–	1.22	–	140	CAS-201
7450	.63	1.28	STLS-351	STRS-351	1.92	–	2.27	–	240	CAS-351
▼ Double acting										
Model number ²⁾										
500	.32	.65	STLD-21	STRD-21	.12	.24	.08	.15	12	CAS-21
1250	.39	.89	STLD-51	STRD-51	.28	.59	.25	.52	25	CAS-51
2025	.47	.90	STLD-92	STRD-92	.49	1.25	.42	1.08	60	CAS-92
2600	.50	1.09	STLD-121	STRD-121	.63	1.23	.70	1.40	100	CAS-121
4200	.55	1.16	STLD-201	STRD-201	1.10	2.35	1.22	2.60	140	CAS-201
7600	.63	1.28	STLD-351	STRD-351	1.92	3.68	2.27	4.35	240	CAS-351

¹⁾ With standard clamp arm. Clamp arms are sold separately (□32). Clamping forces for single-acting models are reduced in order to overcome return spring force.

²⁾ For models with straight plunger movement, replace L or R with S.



Note: Call Enerpac to order models with BSPP port connections.

Dimensions in inches []

Left turning models	A	B	C	C1	C2	D	D1	D2	F	G	H	J1
							∅					
▼ Single acting												
STLS-21	4.41	2.32	1.04	1.69	0.98	1.125-16 UN	1.54	1.29	0.39	SAE#2	0.39	2.09
STLS-51	5.33	2.73	1.08	1.97	0.98	1.375-18 UNEF	1.88	1.49	0.63	SAE#4	0.38	2.60
STLS-92	5.68	3.21	1.32	2.22	1.19	M48 X 1,5	2.47	1.90	0.98	G1/4"	0.51	1.70
STLS-121	6.75	3.37	1.09	2.18	1.00	1.875-16 UN	2.38	2.00	0.87	SAE#4	0.38	3.38
STLS-201	6.57	3.74	1.40	2.56	1.26	2.500-16 UN	2.99	2.56	1.26	SAE#4	0.52	2.06
STLS-351	7.45	4.24	1.38	2.66	1.26	3.125-16 UN	3.48	3.15	1.50	SAE#4	0.51	2.45
▼ Double acting												
STLD-21	4.41	2.32	1.04	1.69	0.98	1.125-16 UN	1.54	1.29	0.39	SAE#2	0.39	2.09
STLD-51	5.33	2.73	1.08	1.97	0.98	1.375-18 UNEF	1.88	1.49	0.63	SAE#4	0.38	2.60
STLD-92	5.68	3.21	1.32	2.22	1.19	M48 X 1,5	2.47	1.90	0.98	G1/4"	0.51	1.70
STLD-121	6.75	3.37	1.09	2.18	1.00	1.875-16 UN	2.38	2.00	0.87	SAE#4	0.38	3.38
STLD-201	6.57	3.74	1.40	2.56	1.26	2.500-16 UN	2.99	2.56	1.26	SAE#4	0.52	2.06
STLD-351	7.45	4.24	1.38	2.66	1.26	3.125-16 UN	3.48	3.15	1.50	SAE#4	0.51	2.45

NOTE: dimensions shown with standard clamp arm.

Accessory Chart

Model Nos.		Mounting flange	Flange nut
Left turning	Right turning		
		Sold Separately ☐ 87 ▶	Sold Separately ☐ 86 ▶

▼ **Single acting**

STLS-21	STRS-21	—	MF-281	FN-281
STLS-51	STRS-51	AW-5	MF-351	FN-351
STLS-92	STRS-92	—	MF-482	FN-482
STLS-121	STRS-121	AW-89	MF-481	FN-481
STLS-201	STRS-201	AW-19	MF-651	FN-651
STLS-351	STRS-351	AW-90	MF-801	FN-801

▼ **Double acting**

STLD-21	STRD-21	—	MF-281	FN-281
STLD-51	STRD-51	AW-5	MF-351	FN-351
STLD-92	STRD-92	—	MF-482	FN-482
STLD-121	STRD-121	AW-89	MF-481	FN-481
STLD-201	STRD-201	AW-19	MF-651	FN-651
STLD-351	STRD-351	AW-90	MF-801	FN-801

-21, 51, 121

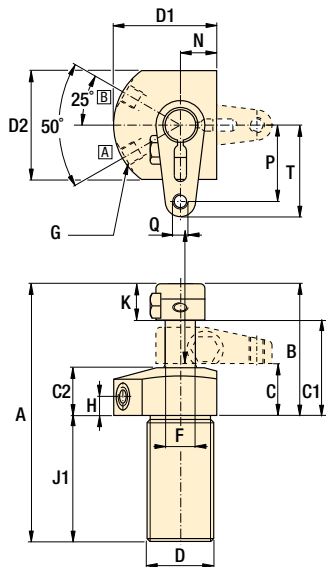

☐ A = Clamping
☐ B = Unclamping (venting)

-92, 201, 351

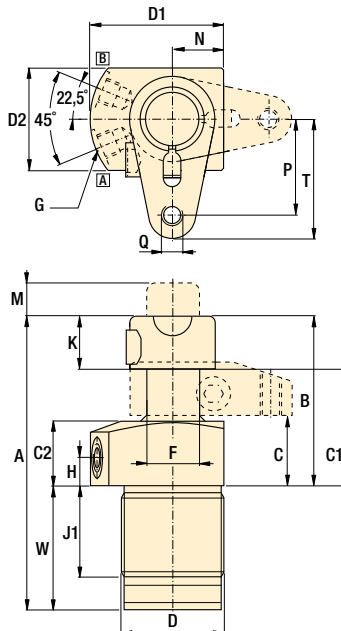

	K	M	N	P	Q	T	W	Y	Z		Right turning models
Single acting ▼											
	0.63	-	0.60	0.97	.250-20 UNC	1.22	-	25°	50°	1.1	STRS-21
	0.76	-	0.75	1.58	.312-18 UNC	1.89	-	25°	50°	2.5	STRS-51
	0.99	0.59	0.95	1.78	M10 x 1,5	2.21	2.47	22.5°	45°	4.4	STRS-92
	1.20	-	1.00	2.03	.375-16 UNC	2.44	-	25°	50°	3.5	STRS-121
	1.19	0.91	1.28	2.18	.500-13 UNC	2.77	2.83	22.5°	45°	7.1	STRS-201
	1.58	1.08	1.57	2.68	.625-11 UNC	3.27	3.22	22.5°	45°	12.1	STRS-351
Double acting ▼											
	0.63	-	0.60	0.97	.250-20 UNC	1.22	-	25°	50°	1.1	STRD-21
	0.76	-	0.75	1.58	.312-18 UNC	1.89	-	25°	50°	2.5	STRD-51
	0.99	-	0.95	1.78	M10 x 1,5	2.21	2.47	22.5°	45°	4.4	STRD-92
	1.20	-	1.00	2.03	.375-16 UNC	2.44	-	25°	50°	3.5	STRD-121
	1.19	-	1.28	2.18	.500-13 UNC	2.77	2.83	22.5°	45°	7.7	STRD-201
	1.58	-	1.57	2.68	.625-11 UNC	3.27	3.21	22.5°	45°	12.1	STRD-351

Force: 475- 7600 lbs

Stroke: .65 - 1.28 inch

Pressure: 500 - 5000 psi

- ☐ E Cilindros giratorios
- ☐ F Vérins de bridage pivotants
- ☐ D Schwenkspannzylinder

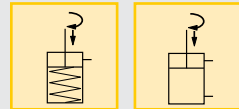

Options

Clamp arms
☐ 32 ▶ 

Work supports
☐ 43 ▶ 

Collet-Lok® swing cylinders
☐ 12 ▶ 

Accessories
☐ 86 ▶ 

Important

30, 45, and 60 degree rotations are available upon request. Add -30, -45 or -60 to end of standard model number to order directly from Enerpac. To order rotation limiter separately, see page 32.

Custom cylinders including longer stroke lengths are available on request.

In case there is a risk of machining coolants and debris being inhaled via the breather vent, it is recommended to pipe this port to an area outside the fixture that is protected from machining coolants and debris.

Do not exceed maximum flow rates.

Swing clamps - Cartridge models

Shown: SCRD-122, SCRD-52



SC series

Enerpac cartridge swing clamps are designed for integrated manifold mounting. This eliminates the need for fittings and tubing on the fixture.

Cartridge swing clamps simplify mounting and optimize clamping effectiveness.

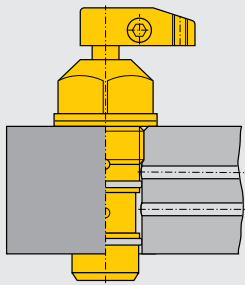

Hydraulic fixture with components on two faces for more efficient production.



Eliminates the need for tubing and fittings

- Minimal space required on fixture
- Can be completely recessed in fixture
- External plumbing not required
- Allows close positioning of adjoining units
- 30, 45 and 60 degree swing angles available on request

i Enerpac compact design cartridge model swing clamps used in conjunction with a cartridge model work support in a typical clamping application.

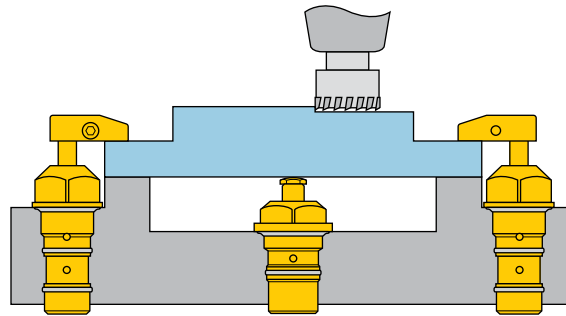

Product selection

Clamping force ¹⁾	Stroke		Left turning	Right turning	Cylinder effective area		Oil capacity		Max. oil flow ¹⁾	Standard clamp arm
	lbs	in			in ²	in ³				
	Clamp	Total			Un-clamp	Clamp	Un-clamp	in ³ /min		
▼ Single acting										
Model number ²⁾										
475	.32	.66	SCLS-22	SCRS-22	.12	-	.08	-	12	CAS-21
1100	.39	.89	SCLS-52	SCRS-52	.28	-	.25	-	25	CAS-51
2400	.50	1.09	SCLS-122	SCRS-122	.63	-	.70	-	100	CAS-121
▼ Double acting										
Model number ²⁾										
500	.32	.66	SCLD-22	SCRD-22	.12	.24	.08	.15	12	CAS-21
1250	.39	.89	SCLD-52	SCRD-52	.28	.59	.25	.52	25	CAS-51
2600	.50	1.09	SCLD-122	SCRD-122	.63	1.23	.70	1.40	100	CAS-121

¹⁾ With standard clamp arm. Clamp arms are sold separately (□32). Clamping forces for single-acting models are reduced in order to overcome return spring force.

²⁾ For models with straight plunger movement, replace L or R with S.

Dimensions in inches []

Left turning models	A	B	C	C1	C2	D1	D2	E	F	
						Ø	Ø	hexagon		
▼ Single acting										
SCLS-22	4.41	2.26	0.98	1.63	0.94	1.51	1.00	1.37	0.39	
SCLS-52	5.33	3.14	1.49	2.39	1.39	2.23	1.37	1.99	0.63	
SCLS-122	6.75	3.8	1.52	2.61	1.43	2.99	2.25	2.74	0.87	
▼ Double acting										
SCLD-22	4.41	2.26	0.98	1.63	0.94	1.51	1.00	1.37	0.39	
SCLD-52	5.33	3.14	1.49	2.39	1.39	2.23	1.37	1.99	0.63	
SCLD-122	6.75	3.80	1.52	2.61	1.43	2.99	2.25	2.74	0.87	

NOTE: dimensions shown with standard clamp arm.

Clamp arms for swing clamps

Shown: CAS-121, CAL-122

Collet-Lok® product line
Swing clamps



Patented Design

- Easy and precise location of the clamp arm in any position
- Arm can be easily installed and fastened while the cylinder is mounted in the fixture to allow exact arm positioning
- Vise not required for fastening arms

Pressure vs clamping force

The use of different length clamp arms requires reduction in applied pressure and resulting clamp force. The charts below show this relationship.

Enerpac's patented clamp arm design attaches to the hydraulic swing cylinder, allowing parts to be clamped at various distances from the hydraulic cylinder. Clamp arms are available in a variety of lengths, or you can use custom machining dimensions to create your own clamp arm configuration.

Ordering rotation limiting spacers

BUILD YOUR PART NUMBER:

SP	186
Clamp force	Angle
02 = 500 lbs	30
05 = 1250 lbs	45
09 = 2025 lbs	60
12 = 2600 lbs	
20 = 4200 lbs	
35 = 7600 lbs	

Example:

SP-12 45-186 converts a 2600 lb. swing cylinder to 45 degree rotation.

The addition of this spacer requires minor disassembly of the clamp. If you are uncomfortable doing this, please contact an authorized Enerpac Service Center.

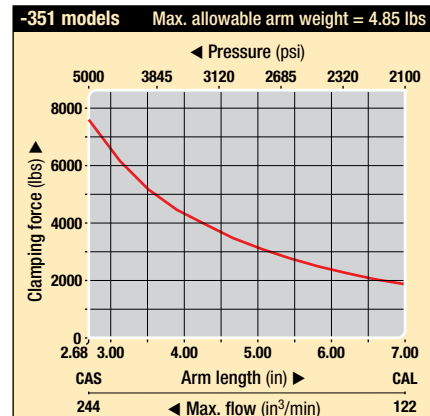
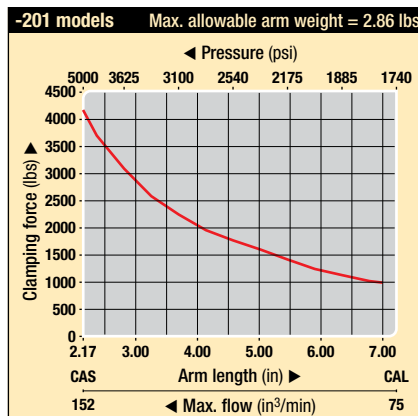
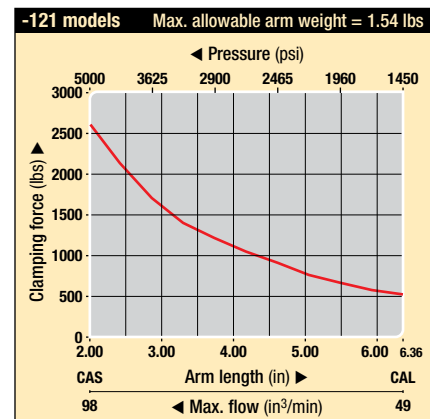
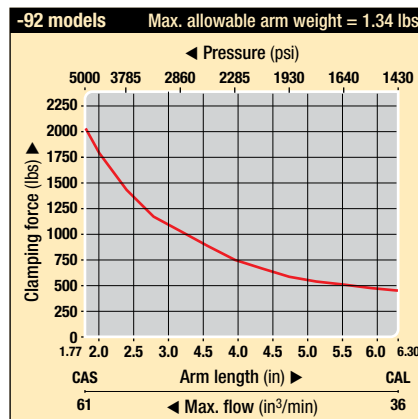
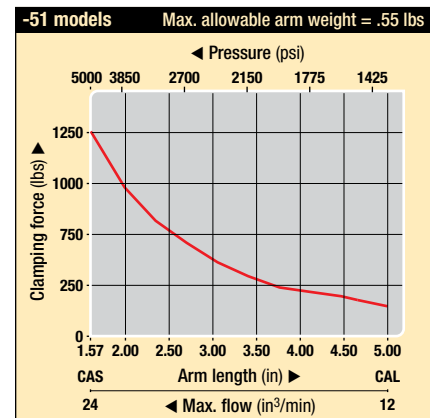
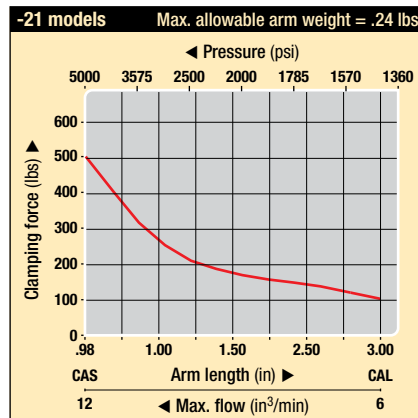

CAS models Standard clamp arms

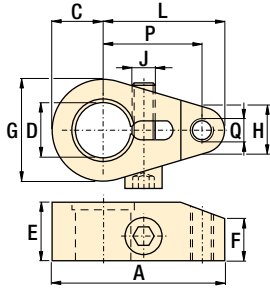

CAL models Long clamp arms

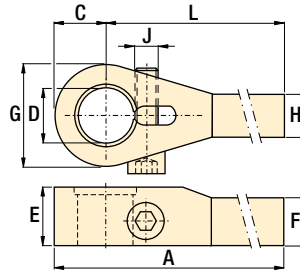

Custom design (for SU, SL, ST and SC models only)

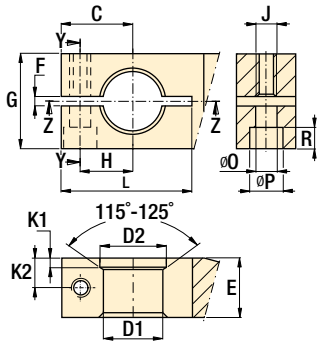

Dimensions in inches [$\Rightarrow \text{mm}$]

Clamp force lbs	Model number	A	C	D	E	F	G	H	J	L	P	Q	Weight lbs
				Ø			Ø					UNC	
▼ Standard clamp arms													
500	CAS-21	1.60	0.38	.393-.395	0.63	0.4	0.76	0.5	.250-28 UNF	1.22	0.97	.250-20	0.1
1250	CAS-51	2.39	0.50	.630-.631	0.76	0.45	1.00	0.62	.312-24 UNF	1.89	1.58	.312-18	0.8
2025	CAS-92	2.99	0.79	.985-.986	0.99	0.62	1.58	0.86	M10 X 1,25	2.21	1.78	M10x1.5	0.7
2600	CAS-121	3.13	0.70	.876-.877	1.20	0.64	1.40	0.82	.375-24 UNF	2.44	2.03	.375-16	1.0
4200	CAS-201	3.72	0.95	1.260-1.262	1.19	0.83	1.90	1.18	.500-20 UNF	2.77	2.18	.500-13	1.0
7600	CAS-351	4.65	1.38	1.497-1.498	1.58	1.17	2.76	1.18	.625-18 UNF	3.27	2.68	.625-11	3.0
▼ Long clamp arms													
500	CAL-22	3.63	0.38	.393-.395	0.63	0.42	0.76	0.45	M6x1.0	3.25	-	-	0.2
1250	CAL-52	5.81	0.50	.630-.631	0.76	0.45	1.00	0.56	M8x1.0	5.31	-	-	1.0
2025	CAL-92	7.09	0.79	.985-.986	0.99	0.63	1.58	0.71	M10x1,25	6.30	-	-	1.2
2600	CAL-122	7.06	0.70	.876-.877	1.20	0.63	1.40	0.73	M10x1,5	6.36	-	-	1.5
4200	CAL-202	7.95	0.95	1.260-1.262	1.19	0.83	1.90	1.00	M12x1,25	7.00	-	-	1.5
7600	CAL-352	8.47	1.38	1.497-1.498	1.58	1.33	2.76	1.19	M16x1,50	7.09	-	-	4.2

Clamp force lbs	C	D1 ¹⁾	D2	E	F	G	H	J	K1	K2	L	O	P	R
		Ø	Ø									Ø	Ø	
▼ Custom design clamp arms ²⁾ (Recommended machining dimensions)														
500	.61	.393-.394	.495-.497	.63	.06-.12	.79	.37	M5x0,8	.122-.138	.33	.98-1.10	.22	.49	.22
1250	.79	.623-.631	.727-.729	.75	.06-.12	1.18	.53	M6x1,0	.161-.177	.39	1.38-1.57	.26	.43	.26
2025	1.18	.984-.985	1.096-1.100	.98	.06-.12	1.57	.87	M8x1,25	.154-.165	.49	2.17-2.36	.35	.55	.35
2600	1.12	.8756-.8766	1.002-1.006	1.18	.06-.12	1.38	.70	.375-24 UNF	.272-.287	.50	2.05-2.25	.39	.63	.31
4200	1.38	1.260-1.261	1.398-1.402	1.18	.06-.12	2.36	.98	M10x1,5	.201-.217	.59	2.44-2.64	.43	.67	.43
7600	1.57	1.496-1.497	1.634-1.638	1.57	.06-.12	2.76	1.18	M10x1,5	.193-.209	.79	3.15-3.35	.43	.67	.43

¹⁾ Surface roughness for D1 should be 63 micro inches.
²⁾ Not for use with Collet-Lok swing clamps.

Force: 500 - 7600 lbs

Pressure: 500 - 5000 psi

- E** Brazos de amarre
- F** Bras de bridage
- D** Spannarme

Options

Gauges and accessories

190 ▶



Flow control valves

155 ▶



Important

Do not exceed maximum oil flow.

If flow rates are exceeded, swing cylinder indexing mechanism may be permanently damaged.

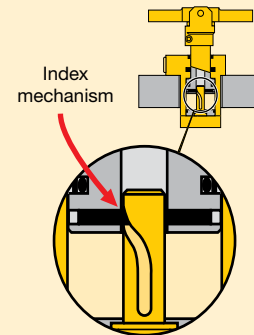

When designing custom clamp arms, the flow rates must be further reduced. This rating should be in proportion to the mass and the center of gravity of the clamp arm.

Example:

If the mass of the arm is twice that of the long arm, flow rates must be reduced by 50%.

Pivoting T-Arms *for double-acting swing clamps*

Shown: CAC-202, CAPT-202; CAC-352, CAPT-352

Collet-Lok® product line
Swing clamps



▶ Clamp arms are used to transmit the force generated by the swing cylinder to the workpiece. The T-arm clamps two workpieces simultaneously with one swing cylinder. Enerpac recommends using the pivoting T-arms with double-acting swing clamps of the SU, SL, ST and SC-series.

Clamping two workpieces with one cylinder

...quick and precise clamp arm positioning

- Easy and precise location of the clamp arm in any position
- Arm can be easily installed and fastened while the cylinder is mounted in the fixture to allow exact arm positioning
- Vise not required for fastening arms or threaded into the fixture
- CAC-92, -202 and -352 are only to be used on double-acting cylinders

i Allowable flow vs arm length

The distribution of the clamp arm force is based upon the length of the T-arm as measured from the pivoting point.

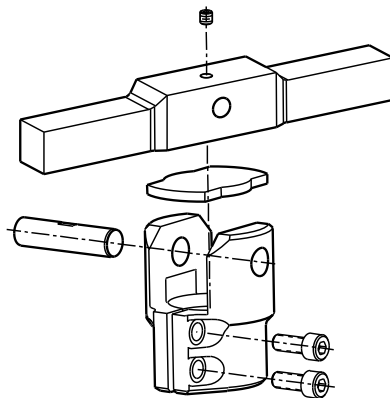

! Important

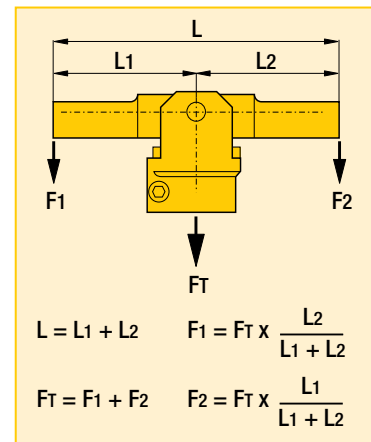

■ Two workpieces are clamped simultaneously with one double-acting swing cylinder by using the Enerpac pivoting T-arm.

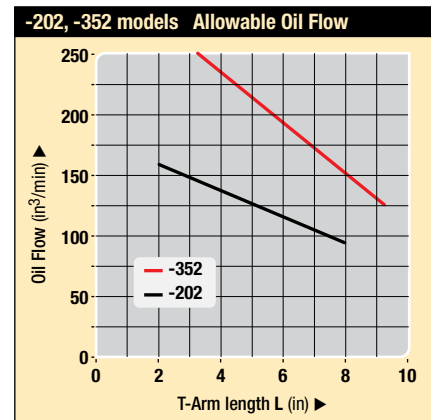
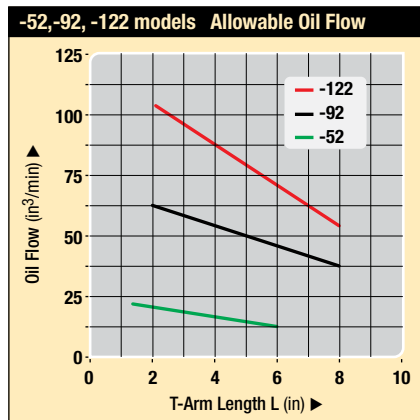

Shown: CAC-202



CA models

Collars for T-arms

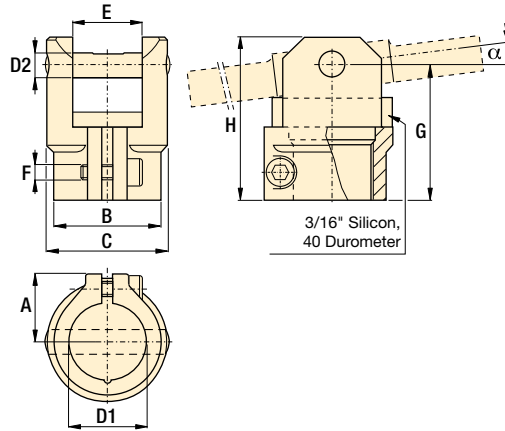

Collars - Dimensions in inches [\varnothing]

Clamp. force lbs	Model number	Max. tilt angle α	A	B	C	D1	D2	E	F	G	H	lbs
									mm			
▼ Collars for T-arms												
1250	CAC-52	20°	.65	.95	1.10	.63	.24	.63	M4x0,7	1.26	88	.20
2025	CAC-92	14°	.87	1.36	1.54	.99	.32	.89	M5x0,8	1.70	115.72	.44
2600	CAC-122	14°	.87	1.36	1.54	.88	.32	.89	M5x0,8	1.70	115.72	.44
4200	CAC-202	10°	1.07	1.84	2.15	1.26	.39	1.13	M6x1,0	2.02	138.60	1.03
7600	CAC-352	10°	1.34	2.15	2.48	1.50	.55	1.39	M8x1,25	2.50	173.80	1.76

Shown: CAPT-202



CAPT models

T-arms (for SU, SL, ST and SC swing clamps)

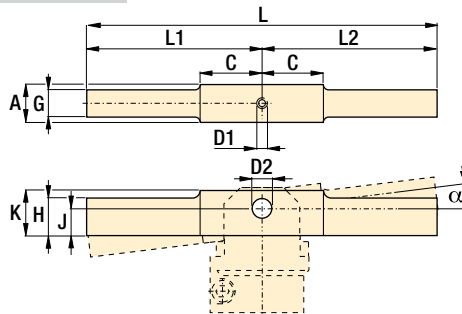

T-arms - Dimensions in inches [\varnothing]

Clamp. force lbs	Model number	A	C	D1*	D2	G	H	J	K	L	L1	L2	lbs
				mm									
▼ Pivoting T-arms													
1250	CAPT-52	.61	1.00	M3x0,5	.237-.241	.50	.50	.39	.75	6.00	3.00	3.00	.59
2025	CAPT-92	.87	1.50	M4x0,7	.316-.320	.72	.72	.59	.87	8.01	4.00	4.00	1.45
2600	CAPT-122	.87	1.50	M4x0,7	.316-.320	.72	.72	.59	.87	8.01	4.00	4.00	1.45
4200	CAPT-202	1.12	1.25	M6x1,0	.395-.399	.87	.87	.64	1.13	8.01	4.00	4.00	2.11
7600	CAPT-352	1.37	.99	M6x1,0	.552-.556	1.18	1.18	.73	1.37	9.01	4.50	4.50	3.92

* Note: D1 equals set screw thread size. Set screw must be long enough to secure the pivot pin.

Installation dimensions in inches [\varnothing]

Clamping force lbs	T-arm model	SU-series C	SU-L-series C	SL-series C	ST-series C	SC-series C
▼ T-arm installation dimensions - Fully unclamped position						
1250	-52	2.90	-	5.50	2.90	3.19
2025	-92	3.13	3.91	6.13	3.32	-
2600	-122	3.55	4.28	6.93	3.55	3.87
4200	-202	3.57	-	6.99	3.97	-
7600	-352	4.04	4.69	7.84	4.31	-

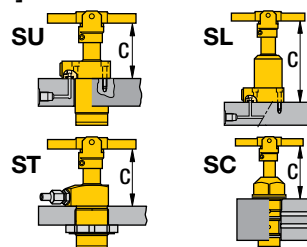

Force: 1250 - 7600 lbs

Pressure: 500 - 5000 psi

- E** Brazos de amarre
- F** Bras de bridage
- D** Spannarme

Options

Gauges and accessories

190 ▶



Flow control valves

155 ▶



Download CAD files from www.enerpacwh.com



30, 45, and 60 degree rotations are available upon request.

Important

For high cycle applications use double-acting cylinders.

Do not exceed maximum oil flow.

If flow rates are exceeded, swing cylinder indexing mechanism may be permanently damaged.

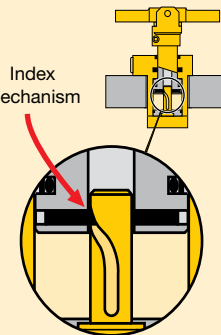

When designing custom clamp arms, the flow rates must be further reduced. This rating should be in proportion to the mass and the center of gravity of the clamp arm.

Example:

If the mass of the arm is twice that of the long arm, flow rates must be reduced by 50%.

Upreach clamp arms *for swing clamps*

Shown: CAU-352, CAU-122, CAU-22



EnergyPac's patented upreach clamp arm design attaches to the hydraulic swing cylinder, allowing parts to be clamped at various distances from the hydraulic cylinder. Clamp arms are available in an extended length which can be machined to fit your unique requirements.

Important

Do not exceed maximum oil flow.

If flow rates are exceeded, swing cylinder indexing mechanism may be permanently damaged.

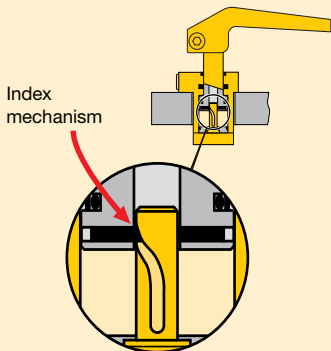

When designing custom clamp arms, the flow rates must be further reduced. This rating should be in proportion to the mass and the center of gravity of the clamp arm.

Example:

If the mass of the arm is twice that of the long arm, flow rates must be reduced by 50%.

Patented Design

- Upreach design allows more flexible part clamping
- Arm can be easily installed and fastened while the cylinder is mounted in the fixture to allow exact arm positioning
- Vise not required for fastening arms
- Arm length can be cut to desired size
- Angled arm with minimal deflection achieves maximum workpiece contact

Pressure vs clamping force

The use of different length clamp arms requires reduction in applied pressure and resulting clamp force. The charts below show this relationship.

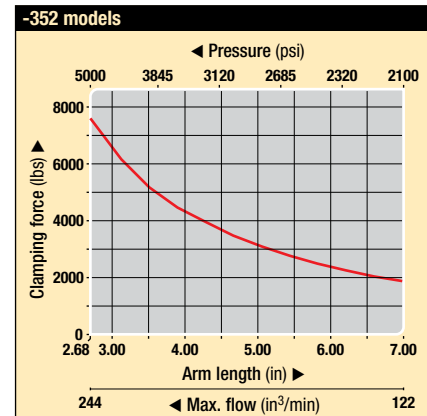
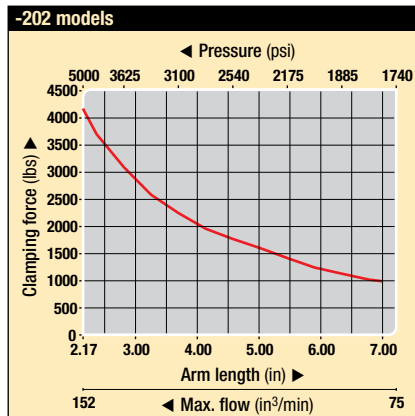
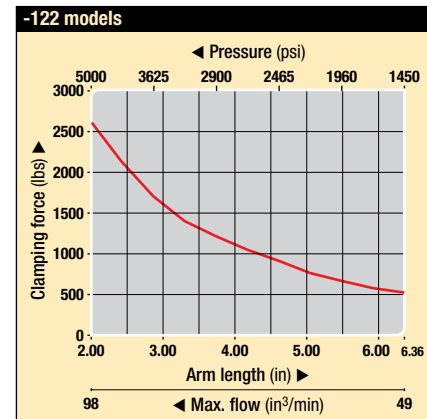
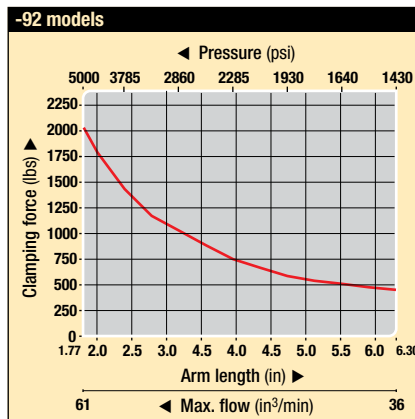
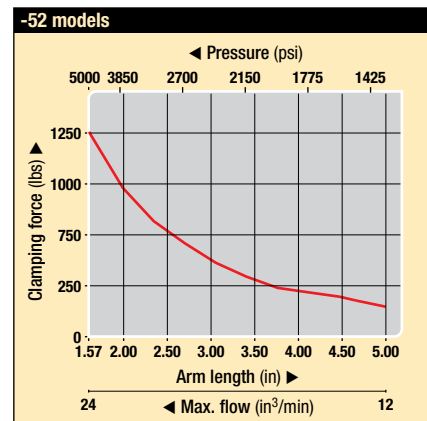
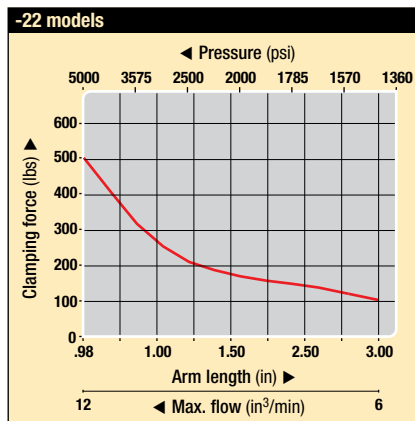

i Angled arms use deflection to improve clamping

Angled arms

Tip engages part first and contact increases as clamping force is applied.

Eliminates “push” effect caused by straight arms deflecting under load.

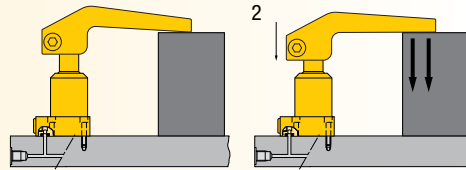

Straight Arms

Great for most applications, but standard deflection can cause part movement and lower the true clamping force.

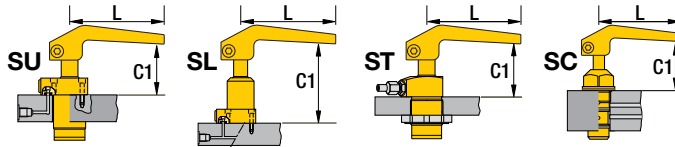
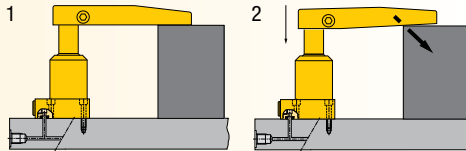

A Installation dimensions in inches []

Model number	Clamp force	L	SU-Series C1	SL-Series C1	ST-Series C1	SC-Series C1
▼ Stock length dimensions						
CAU-22	100	3.25	2.23	4.32	2.23	2.09
CAU-52	200	5.31	2.82	5.42	2.82	3.10
CAU-92	450	6.30	2.90	5.89	3.10	-
CAU-122	500	6.36	3.29	6.67	3.29	3.61
CAU-202	1000	6.99	3.47	6.90	3.75	-
CAU-352	1900	7.09	3.90	7.56	4.18	-
▼ Minimum length dimensions						
CAU-22	500	0.98	2.35	4.44	2.35	2.21
CAU-52	1250	1.57	3.02	5.62	3.02	3.30
CAU-92	2025	1.77	3.14	6.13	3.34	-
CAU-122	2600	2.00	3.52	6.90	3.52	3.84
CAU-202	4200	2.17	3.72	7.15	4.00	-
CAU-352	7600	2.68	4.21	7.87	4.49	-

CAU models Upreach clamp arms

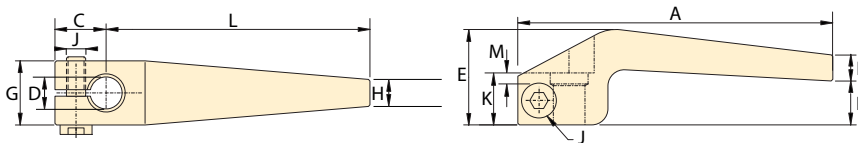

A Dimensions in inches []

Model number	A	B	B	C	D	E	F	F	G	H	H	J	K	L	L	M	lbs
		Std.	Min.				Std.	Min.		Std.	Min.	mm		Std.	Min.		
CAU-22	3.88	0.54	0.66	0.63	.393-.394	1.17	0.32	0.54	0.79	0.33	0.82	M6 x 1,0	0.64	3.25	0.98	0.04	0.3
CAU-52	6.10	0.85	1.05	0.79	.630-631	1.65	0.26	0.57	1.18	0.47	1.25	M6 x 1,0	0.75	5.31	1.57	0.05	0.9
CAU-92	7.48	0.93	1.17	1.18	.985-.986	1.89	0.43	0.76	1.57	0.57	1.61	M8 x 1,25	0.98	6.30	1.77	0.09	1.7
CAU-122	7.48	1.11	1.34	1.12	.876-.877	2.25	0.50	1.15	1.50	0.65	1.56	M10 x 1,5	1.18	6.36	2.00	0.15	2.2
CAU-202	8.37	1.27	1.52	1.38	1.260-1.261	2.41	0.52	0.96	2.36	0.68	2.14	M10 x 1,5	1.18	6.99	2.17	0.11	3.7
CAU-352	8.66	1.62	1.93	1.57	1.497-1.498	3.14	0.74	1.35	2.60	0.62	2.13	M10 x 1,5	1.58	7.09	2.68	0.07	5.9

Refer to clamping force charts on page 36.
Never cut shorter than indicated minimum length.

Force: 100 - 7600 lbs
Pressure: 500 - 5000 psi

- E** Brazos de amarre
- F** Bras de bridage
- D** Spannarme

i Options

Sequence valves [152](#)

Flow control valves [155](#)

Download CAD files from www.enerpacwh.com

Swing clamps

Work supports

Linear cylinders

Power sources

Valves

Pallet components

System components

Yellow pages

Shown: SC-3, SC-1



SC series

These swing clamps rotate 90° as they begin their stroke, continuing without rotation for the final clamping stroke. Cylinders can be changed to left swing, right swing, or pull applications by loosening the side plug and then rotating the plunger to a desired position.

The SC-1 and SC-3 include a retract spring for single-acting operation. Both cylinders can be operated as double-acting cylinders by connecting a retract line to the vent port.

Changeable swing function

...with 360° fully adjustable clamp arm

- Changeable swing function: clamp arm movement can be adjusted to left or right swing, or straight pull function
- 88-92° clamp arm swing arc
- Easy installation: built-in mountings and brackets
- Compact design for use in limited space applications
- Easy and precise locating of arm for clamp positioning
- Single or double-acting cylinders to suit variety of hydraulic requirements

Force: 500 - 2164 lbs

Stroke: .78 - 1.49 inch

Pressure: 1500 - 3000 psi

- Ⓔ Cilindros giratorios
- Ⓕ Vérins de bridage pivotants
- Ⓓ Schwenkspannzylinder

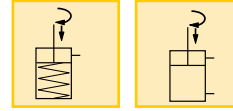

Arm length in	Max. pressure psi	Clamping force lbs
---------------	-------------------	--------------------

▼ SC-1

-	3000	2640
2.00 ²⁾	3000	2164
3.00	3000	1960
4.00	3000	1740
5.00	2400	1200
6.00	2000	840

▼ SC-3

-	3000	700
1.00 ²⁾	3000	500
2.00	2000	250

Selection chart

Clamping force ¹⁾	Stroke		Model number	Cylinder effective area		Oil capacity	
	lbs	in		in ²	in ³		
2164	.50	1.49	SC-1	.98	1.767	1.47	2.65
500	.25	.78	SC-3	.245	.442	.184	.331

¹⁾ With standard clamp arm (included with cylinder).

Note: - Long clamp arms can be fabricated by the user.
- For long clamp arms, use VFC series flow control valves.

²⁾ Standard clamp arm (included).

SC-1

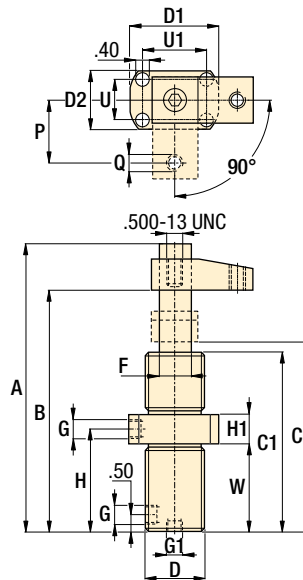

SC-3

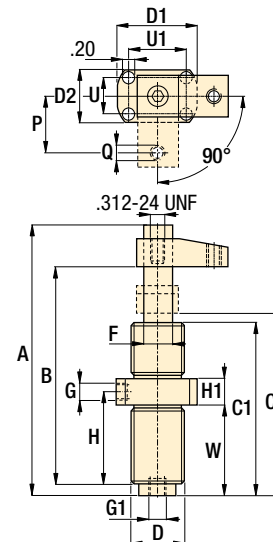

Product dimensions in inches [\pm]

Model number	A	B	C	C1	D	D1	D2	F	G	G1	H	H1	P	Q	U	U1	W	lbs
SC-1	8.88	7.37	5.87	5.74	1.875-16UN	2.90	1.88	1.00	.250-18	.125-27	3.31	.88	2.00	.375-16	1.28	2.06	2.87	6
SC-3	5.27	4.26	3.71	3.48	1.00-12UNF	2.00	1.13	.50	.125-27	.125-27	2.15	.63	1.00	.250-20	.75	1.50	2.03	2

Force: 1375 - 4375 lbs

Stroke: .25 - .43 inch

Pressure: 1200 - 2500 psi

- E** Cilindros giratorios
- F** Vérins de bridage pivotants
- D** Schwenkspannzylinder

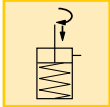

Adjustable clamping stroke

...turns clockwise or counter-clockwise

- Adjustable bolt in clamp arm for clamping stroke adjustment
- Low profile, ideal for limited space applications
- Quick swing action allows clamp arm to swing free of cutter and reclamp after it has passed
- 94-100° clamp arm swing arc

Shown: ASC-30



ASC series

Clamping arm rotates 97° clockwise or counter-clockwise (requires easily changed rotation spring) to position itself over the workpiece. Then, a vertical plunger exerts an upward thrust on the back end of the swing arm providing a powerful downward pressure to clamp the workpiece.

ASC-30, -100

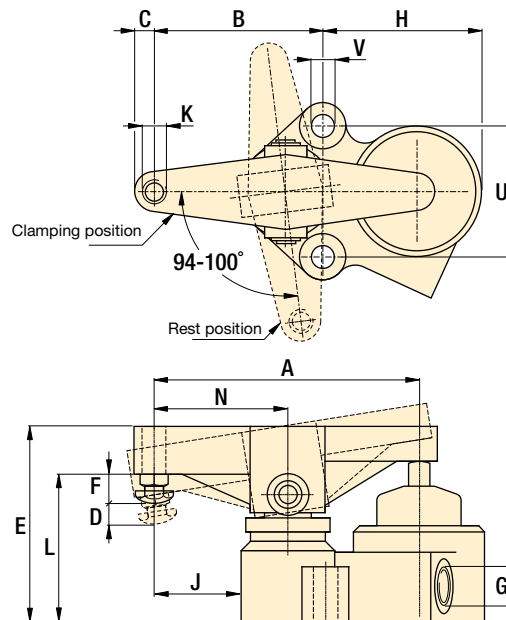

Selection chart

Clamping force	Stroke	Model number	Operating pressure	Cylinder effective area	Oil capacity	Max. oil flow	
lbs	in		psi	in ²	in ³	in ³ /min	lbs
1375	.25	ASC-30	1200 - 2500	.55	.30	115	6
4375	.43	ASC-100	1200 - 2500	1.76	1.22	115	18

Product dimensions in inches []

Model number	A	B	C	D	E	F	G	H	J	K	L	N	U	V	
							NPT				UN				Ø
ASC-30	5.00	3.38	.50	.25	3.50	.75	.125-27	2.75	1.63	.500-13	2.75	2.50	2.50	.41	
ASC-100	7.00	4.50	.53	.43	5.25	.73	.125-27	4.25	2.25	.500-13	4.00	3.50	3.50	.63	

Important

For high cycle applications use double-acting cylinders.

View of a machining fixture with ASC-30 clamping cylinders.



Three-position swing cylinder *Application & selection*

Shown: WTR-24



WTR series

The three position swing cylinder rotates 90° only after the plunger has completely extended. This feature allows the clamp to be mounted beneath the workpiece, where the clamp travels through the part for clamping.

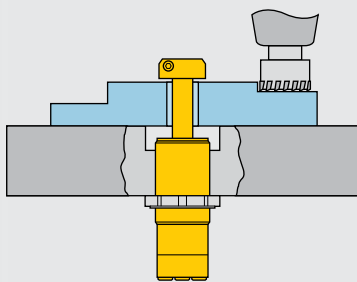

Unobstructed part loading

- Plunger rotates only when cylinder is fully extended, to minimize obstructions
- Ideal for mounting beneath the fixture, as the clamp does not rotate until the workpiece has been cleared
- Stainless steel body for additional corrosion resistance
- Three port design for fewer hydraulic connections
- Fully threaded body for easy installation
- Standard two sided clamp arm included
- Clamp arm design makes mounting easy

Operation sequence

The three position swing cylinder is ideal for parts which have a through hole. The clamp allows completely unobstructed part loading.

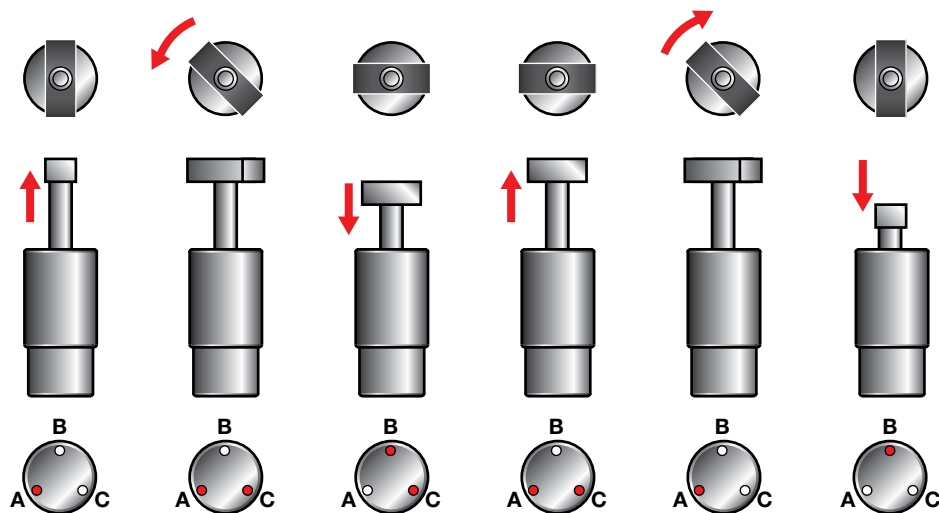

Step 1

Pressurize port A. Plunger extends through workpiece.

Step 2

Keep port A pressurized. Pressurize port C. Plunger makes 90° flat rotation.

Step 3

Keep port C pressurized. Pressurize port B. Plunger retracts: clamp force is applied.

Step 4

Keep port C pressurized. Pressurize port A. Plunger extends: clamp force is released.

Step 5

Keep port A pressurized. Depressurize port C. Plunger makes 90° flat rotation.

Step 6

Pressurize port B. Plunger retracts through workpiece.

Selection chart

Clamping force ¹⁾	Stroke	Model number ²⁾	Cylinder effective area		Oil capacity		Max. oil flow	Maximum cycle rate
			in ²	in ²	in ³	in ³ /min		
lbs	in		Clamp.	Unclamp.	Clamp.	Unclamp.	in ³ /min	cycles /min
5000	2.50	WTR-24*	.98	1.77	2.5	4.4	116	4

¹⁾ When using optional CA-28 clamp arm, max. operating pressure is 2000 psi.

²⁾ Standard clamp arm included.

* This product is made to order. Please contact Enerpac for delivery information before specifying in your design.

WTR-24

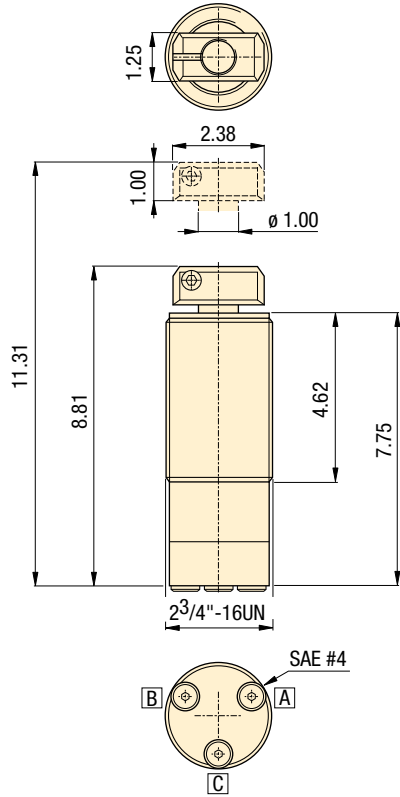

- A** = Advance
- B** = Retract
- C** = Rotate 90°

***i* Optional CA-28 clamp arm**

The WTR-24 has a two-sided standard clamp arm included. The CA-28 clamp arm can be used to secure the workpiece on one side only, though the clamping pressure must be reduced to 2000 psi maximum.

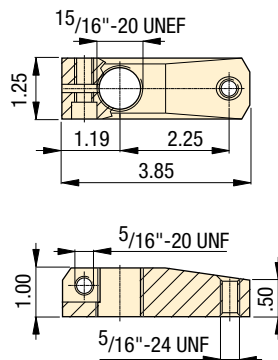

Force: 1960 - 5000 lb

Stroke: 2.50 inch

Pressure: 2000 - 5000 psi

- E** Cilindros giratorios
- F** Vérins de bridage pivotants
- D** Schwenkspannzylinder

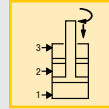

***i* Options**

High pressure filters

193



Fittings

194



Valves

136



***w* Important**

It is highly recommended that system filtration be used to ensure reliable operation.

Do not exceed maximum pressure and flow rates.

For recommended valving schemes, please refer to page 42.

Clamp arm movement: 90° ± 3° flat rotation.

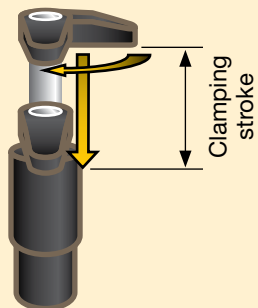

⚠ Important

Circuit must include a Pressure Reducing Valve (PRV-4) in the "A" port circuit to reduce the pressure in Unclamp to prevent damage to the cylinder.

Recommended valving system for WTR-24

- 4-way 3-position closed center valves are recommended
- Valves can be manual or solenoid operated
- Valves must be cycled as shown for proper actuation of the WTR-24

