

Shown: PLSS-121, PUSD-121



▶ Hydraulic pull cylinders utilize hydraulic pressure to hold down parts in a fixture. The guided plunger maintains orientation during the full clamping cycle, eliminating the need for an external guide. Internally threaded plunger ends accept various custom attachments to assist in the clamping process.

Enerpac offers both single- and double-acting pull cylinders, with capacities ranging from 1250 to 9600 lbs. for pulling and 2950 to 18,400 lbs. for pushing applications.

■ Hydraulic fixture with pull and swing cylinders, manifold and threaded cylinders for positioning and holding the work piece during milling process of gun breeches.



Compact and full featured design

- Guided linear plunger movement
- Compact design allows for efficient fixture layout
- Variety of mounting styles to meet design needs
- Internal plunger thread and flats across plunger top allow easy mounting of attachments
- Choice of porting styles to meet system and design requirements
- Single- and double-acting cylinders to suit a variety of hydraulic requirements

i Select your pull cylinder type:

Single acting

- The obvious choice when there are few system restrictions, and there are not many units retracting simultaneously
- Valving and plumbing is less complex

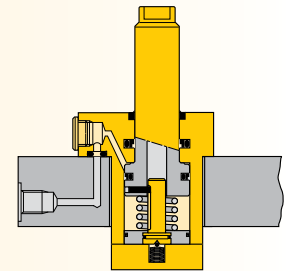

Double acting

- When greater control is required during the unclamp cycle
- When heavy attachments are being used
- When timing sequences are critical: less sensitive to system back pressures resulting from long tube lengths or numerous components being retracted at the same time

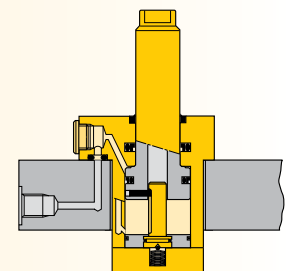

i Select your mounting method:

PU series, Upper flange mounting

- Flexible design allows for manifold or threaded oil port connection
- Fixture hole does not require tight tolerances
- Easy installation with only 3 or 4 mounting bolts

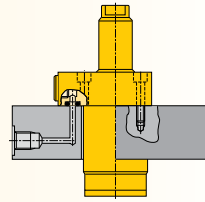

60 ▶

PL series, Lower flange mounting

- Flexible design allows for manifold or threaded port connection
- No fixture hole required
- Easy installation with only 3 or 4 mounting bolts

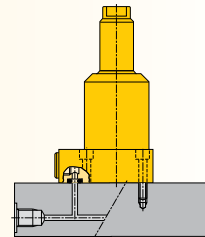

62 ▶

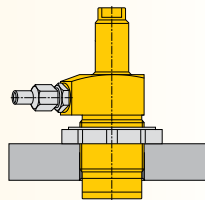

PT series, Threaded body mounting

- Body thread for precise cylinder height positioning
- Threaded oil port connection
- Can be threaded directly into the fixture and secured in position by means of standard flange nuts



64 ▶

globe Product selection

| Cylinder capacity | | Stroke | Upper flange | Lower flange | Threaded body |
|------------------------|--------|--------|---|---|--|
| lbs | | in |  |  |  |
| Pull | Push | | | | |
| ▼ Single acting | | | | | |
| Model number | | | | | |
| 1250 | – | .89 | PUSS-51 | PLSS-51 | PTSS-51 |
| 2950 | – | 1.10 | PUSS-121 | PLSS-121 | PTSS-121 |
| ▼ Double acting | | | | | |
| Model number | | | | | |
| 1400 | 2950 | .89 | PUSD-51 | PLSD-51 | PTSD-51 |
| 2475 | 6300 | .87 | PUSD-92 | PLSD-92 | PTSD-92 |
| 3150 | 6150 | 1.10 | PUSD-121 | PLSD-121 | PTSD-121 |
| 9600 | 18,400 | 1.20 | PUSD-351 | PLSD-351 | PTSD-351 |

Note: - Call Enerpac to order models with metric thread and BSPP port connections.
- Pull forces for single-acting cylinders reduced due to spring force.

www.enerpacwh.com

Pull force: 1250-9600 lbs

Push force: 2950-18,400 lbs

Stroke: 0.87-1.20 inch

Pressure: 500-5000 psi

E Cilindros de tracción

F Verins traction

D Zugzylinder

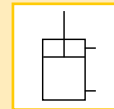
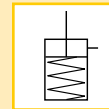

lightbulb Options

Accessories

86 ▶



Collet-Lok® push cylinders

18 ▶



Work supports

43 ▶



Swing cylinders

22 ▶



Sequence valves

152 ▶



Pull cylinders - Upper flange models

Shown: PUSS-51, PUSD-121



PU series

Upper flange pull cylinders are designed for integrated manifold mounting solutions.

Hydraulic connections are made through SAE or BSPP oil connection or the standard integrated O-ring ports.

Oil connection

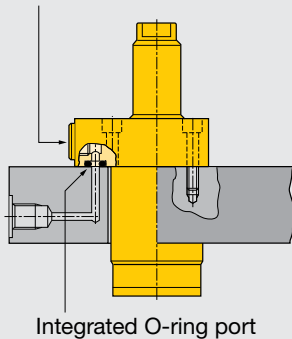

Integrated O-ring port

■ Enerpac upper flange pull cylinders in a fixture for gun breech production.



Minimal mounting height

...when space is at a premium

- Guided linear plunger movement
- Flexible design allows for manifold or threaded port connection
- Low profile mounting style allows body to be below mounting surface
- Internal plunger thread allows easy mounting of attachments
- Simple mounting preparation
- Easy to machine fixture hole: does not require tight tolerances
- Easy assembly: 3 or 4 mounting bolts
- Double oil connection: threaded port or manifold mount

Product selection

| Cylinder capacity | | Stroke | Model number | Cylinder effective area | | Oil capacity | |
|------------------------|----------|--------|-----------------|-------------------------|----------------------|----------------------|----------------------|
| lbs Pull | lbs Push | in | | in ² Pull | in ² Push | in ³ Pull | in ³ Push |
| ▼ Single acting | | | | | | | |
| 1250 | – | .89 | PUSS-51 | .28 | – | .25 | – |
| 2950 | – | 1.10 | PUSS-121 | .63 | – | .70 | – |
| ▼ Double acting | | | | | | | |
| 1400 | 2950 | .89 | PUSD-51 | .28 | .59 | .25 | .53 |
| 2475 | 6300 | .87 | PUSD-92 | .49 | 1.25 | .42 | 1.08 |
| 3150 | 6150 | 1.10 | PUSD-121 | .63 | 1.23 | .70 | 1.40 |
| 9600 | 18,400 | 1.20 | PUSD-351 | 1.92 | 3.68 | 2.27 | 4.35 |

Note: - Call Enerpac to order models with BSPP oil connections.
- Pull forces for single-acting cylinders reduced due to spring force.

Dimensions in inches []

| Model number | A | B | C1 | D | D1 | D2 | E | E1 | F | H |
|------------------------|------|------|------|------|------|------|------|------|------|------|
| | | | | ∅ | | | ∅ | ∅ | | |
| ▼ Single acting | | | | | | | | | | |
| PUSS-51 | 5.07 | 4.18 | 0.98 | 1.37 | 2.13 | 2.25 | 0.63 | 0.59 | 0.51 | 0.55 |
| PUSS-121 | 6.31 | 5.21 | 1.00 | 1.87 | 2.62 | 2.88 | 0.87 | 0.82 | 0.68 | 0.61 |
| ▼ Double acting | | | | | | | | | | |
| PUSD-51 | 5.07 | 4.18 | 0.98 | 1.37 | 2.13 | 2.25 | 0.63 | 0.59 | 0.51 | 0.55 |
| PUSD-92 | 5.43 | 4.57 | 0.98 | 1.88 | 2.76 | 2.13 | 0.98 | 0.93 | 0.70 | 0.49 |
| PUSD-121 | 6.31 | 5.21 | 1.00 | 1.87 | 2.62 | 2.88 | 0.87 | 0.82 | 0.68 | 0.61 |
| PUSD-351 | 8.04 | 6.83 | 0.98 | 3.14 | 3.94 | 3.50 | 1.50 | 1.42 | 1.13 | 0.49 |

Installation dimensions in inches

| Pull force lbs | Fixture hole Ø D3 | Mounting thread J UNF | Min. depth J2 | Manifold O-ring ¹⁾ ARP numbers or Inside Ø x thickness |
|----------------|-------------------|-----------------------|---------------|---|
| 1400 | 1.39 | .250-28 | .65 | 568-011 |
| 2475 | 1.93 | M6 | .59 | .17 x .139 |
| 3150 | 1.89 | .312-24 | .80 | 568-011 |
| 9600 | 3.06 | .375-24 | .74 | .17 x .139 |

¹⁾ O-ring material: polyurethane, 92 Durometer

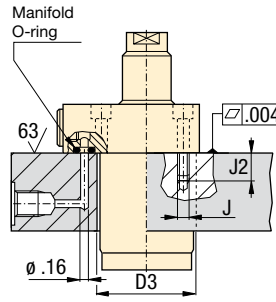

-51, 121

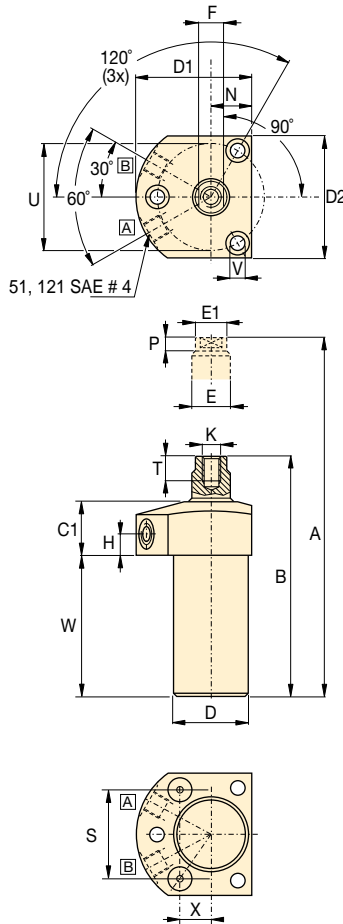

-92, 351

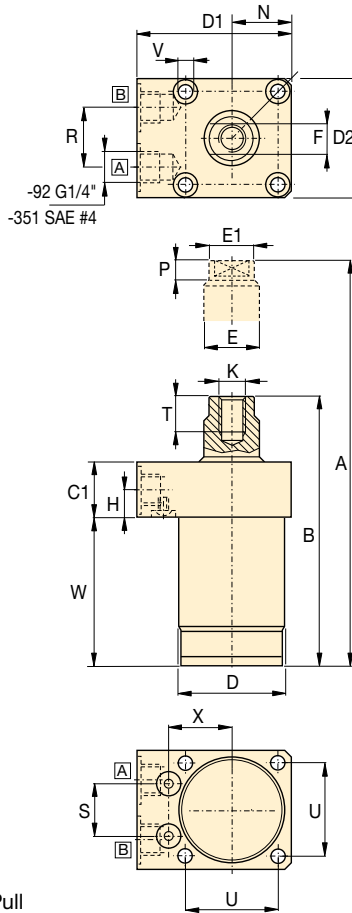

- Pull force: 1250-9600 lbs**
- Push force: 2950-18,400 lbs**
- Stroke: .87-1.20 inch**
- Pressure: 500-5000 psi**

- E Cilindros de tracción**
- F Verins traction**
- D Zugzylinder**

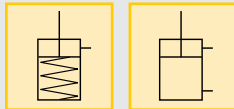

Options

Accessories 86 ▶

Collet-Lok® push cylinders 18 ▶

Swing cylinders 22 ▶

Sequence valves 152 ▶

Important

Single-acting cylinders can be vented through the manifold port.

The upper flange pull cylinder has a bolt pattern which is identical to its lower flange equivalent, enabling interchangeability.

In case there is a risk of machining coolants and debris being inhaled via the breather vent, it is recommended to pipe this port to an area outside the fixture that is protected from machining coolants and debris.

| | K | N | P | R | S | T | U | V | W | X | lbs | Model number |
|--|-------------|------|------|------|-------|------|------|------|------|-------|------|------------------------|
| | | | | | | | | Ø | | | | |
| | | | | | | | | | | | | Single acting ▼ |
| | .312-24 UNF | 0.75 | 0.23 | - | 1.614 | 0.62 | 1.97 | 0.27 | 2.60 | 0.565 | 2.5 | PUSS-51 |
| | .500-20 UNF | 0.99 | 0.37 | - | 2.048 | 0.75 | 2.50 | 0.35 | 3.38 | 0.717 | 3.5 | PUSS-121 |
| | | | | | | | | | | | | Double acting ▼ |
| | .312-24 UNF | 0.75 | 0.23 | - | 1.614 | 0.62 | 1.97 | 0.27 | 2.60 | 0.565 | 2.5 | PUSD-51 |
| | M10 x 1.50 | 1.04 | 0.41 | 1.02 | 0.934 | 0.63 | 1.65 | 0.26 | 2.99 | 1.128 | 4.4 | PUSD-92 |
| | .500-20 UNF | 0.99 | 0.37 | - | 2.048 | 0.75 | 2.50 | 0.35 | 3.38 | 0.717 | 3.5 | PUSD-121 |
| | M16 x 2.00 | 1.71 | 0.51 | 1.02 | 1.356 | 1.22 | 2.76 | 0.43 | 3.80 | 1.637 | 12.3 | PUSD-351 |

Pull cylinders - Lower flange models

Shown: PLSS-51, PLSS-121



PL series

The lower flange cylinders are designed for integrated manifold mounting solutions. Hydraulic connections are made through SAE or BSPP oil connection or the standard integrated O-ring ports.

Oil connection

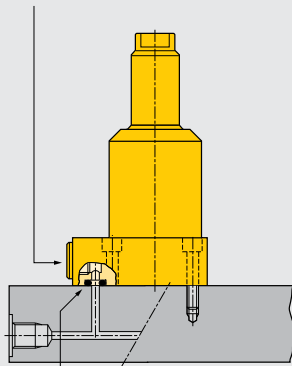

Integrated O-ring port

Minimal mounting height

...when space is at a premium

- Guided linear plunger movement
- Flexible design allows for manifold or threaded port connection
- Low profile mounting style allows body to be below mounting surface
- Internal plunger thread allows easy mounting of attachments
- Easiest mounting preparation in the line
- Easy to machine fixture hole: does not require tight tolerances
- Easy assembly: 3 or 4 mounting bolts
- Double oil connection: threaded port or manifold mount

Product selection

| Cylinder capacity | | Stroke | Model number | Cylinder effective area | | Oil capacity | |
|------------------------|--------|--------|-----------------|-------------------------|------|----------------------|------|
| lbs Pull | Push | in | | in ² Pull | Push | in ³ Pull | Push |
| ▼ Single acting | | | | | | | |
| 1250 | – | .89 | PLSS-51 | .28 | – | .25 | – |
| 2950 | – | 1.10 | PLSS-121 | .63 | – | .70 | – |
| ▼ Double acting | | | | | | | |
| 1400 | 2950 | .89 | PLSD-51 | .28 | .59 | .25 | .53 |
| 2475 | 6300 | .87 | PLSD-92 | .49 | 1.25 | .42 | 1.08 |
| 3150 | 6150 | 1.10 | PLSD-121 | .63 | 1.23 | .70 | 1.40 |
| 9600 | 18,400 | 1.20 | PLSD-351 | 1.92 | 3.68 | 2.27 | 4.35 |

Note: - Call Enerpac to order models with BSPP oil connections.
- Pull forces for single-acting cylinders reduced due to spring force.

Dimensions in inches []

| Model number | A | B | C1 | D | D1 | D2 | E | E1 | F | H |
|------------------------|------|------|------|------|------|------|------|------|------|------|
| | | | | ∅ | | | ∅ | ∅ | | |
| ▼ Single acting | | | | | | | | | | |
| PLSS-51 | 5.07 | 4.18 | 0.98 | 1.37 | 2.13 | 2.25 | 0.63 | 0.59 | 0.51 | 0.55 |
| PLSS-121 | 6.31 | 5.21 | 1.00 | 1.87 | 2.62 | 2.88 | 0.87 | 0.82 | 0.68 | 0.61 |
| ▼ Double acting | | | | | | | | | | |
| PLSD-51 | 5.07 | 4.18 | 0.98 | 1.37 | 2.13 | 2.25 | 0.63 | 0.59 | 0.51 | 0.55 |
| PLSD-92 | 5.43 | 4.57 | 0.98 | 1.88 | 2.76 | 2.13 | 0.98 | 0.93 | 0.7 | 0.49 |
| PLSD-121 | 6.31 | 5.21 | 1 | 1.87 | 2.62 | 2.88 | 0.87 | 0.82 | 0.68 | 0.61 |
| PLSD-351 | 8.04 | 6.83 | 0.98 | 3.14 | 3.94 | 3.5 | 1.5 | 1.42 | 1.13 | 0.49 |

Installation dimensions in inches

| Pull force lbs | Mounting thread J UNF | Minimum depth J2 | Manifold O-ring ¹⁾ ARP numbers or inside Ø x thickness |
|----------------|-----------------------|------------------|---|
| 1400 | .250-28 | .65 | 568-011 |
| 2475 | M6 | .59 | .17 x .139 |
| 3150 | .312-24 | .80 | 568-011 |
| 9600 | .375-24 | .74 | .17 x .139 |

¹⁾ O-ring material: polyurethane, 92 Durometer

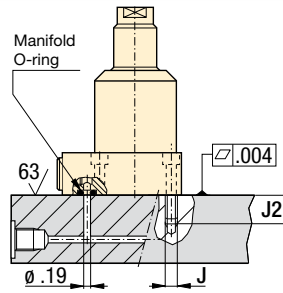

-51, -121

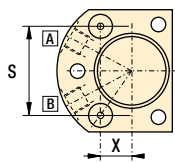
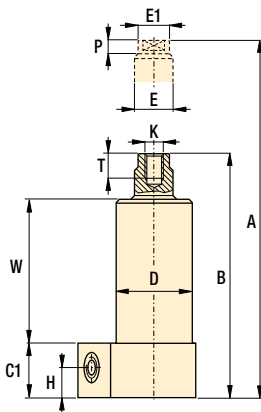
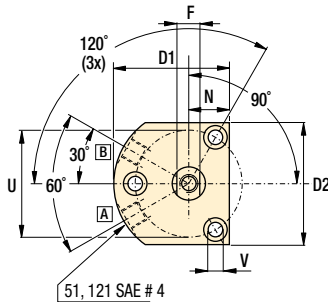

-92, -351

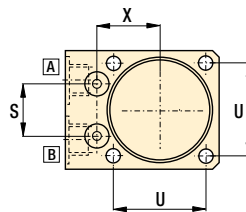
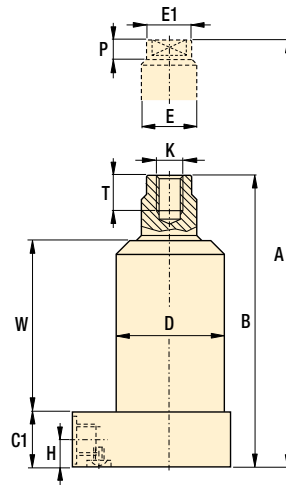
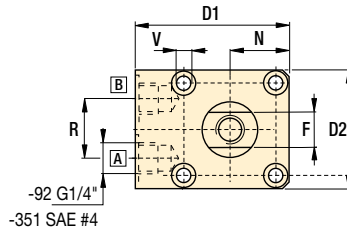

A = Pull
B = Push (venting)

- Pull force: 1250-9600 lbs**
- Push force: 2950-18,400 lbs**
- Stroke: .86-1.20 inch**
- Pressure: 500-5000 psi**

- E** Cilindros de tracción
- F** Verins traction
- D** Zugzylinder

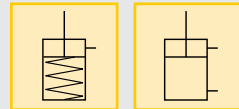

Options

Accessories  86 ▶

Collet-Lok® push cylinders  18 ▶

Swing cylinders  22 ▶

Sequence valves  152 ▶

Important

- Single-acting cylinders can be vented through the manifold port.
- The lower flange pull cylinder has a bolt pattern which is identical to its upper flange equivalent, enabling interchangeability.

In case there is a risk of machining coolants and debris being inhaled via the breather vent, it is recommended to pipe this port to an area outside the fixture that is protected from machining coolants and debris.

| | K | N | P | R | S | T | U | V | W | X |  | Model number |
|--|------------------------|------|------|------|-------|------|------|------|------|-------|---|-----------------|
| | | | | | | | | Ø | | | lbs | |
| | Single acting ▼ | | | | | | | | | | | |
| | .312-24 UNF | 0.75 | 0.23 | - | 1.614 | 0.62 | 1.97 | 0.27 | 2.60 | 0.565 | 2.5 | PLSS-51 |
| | .500-20 UNF | 0.99 | 0.37 | - | 2.048 | 0.75 | 2.50 | 0.35 | 3.38 | 0.717 | 3.5 | PLSS-121 |
| | Double acting ▼ | | | | | | | | | | | |
| | .312-24 UNF | 0.75 | 0.23 | - | 1.614 | 0.62 | 1.97 | 0.27 | 2.60 | 0.565 | 2.5 | PLSD-51 |
| | M10 x 1.50 | 1.04 | 0.41 | 1.02 | 0.934 | 0.63 | 1.65 | 0.26 | 2.99 | 1.128 | 4.4 | PLSD-92 |
| | .500-20 UNF | 0.99 | 0.37 | - | 2.048 | 0.75 | 2.50 | 0.35 | 3.38 | 0.717 | 3.5 | PLSD-121 |
| | M16 X 2.00 | 1.71 | 0.51 | 1.02 | 1.356 | 1.22 | 2.76 | 0.43 | 3.80 | 1.637 | 12.3 | PLSD-351 |

Pull cylinders - Threaded body models

Shown: PTSS-51, PTSD-121



PT-series

The threaded body pull cylinders can be bolted to the fixture.

This allows easy installation or removal of the unit and does not require machined fixture holes.

The cylinder is adjusted to the appropriate height, and then locked in place using a flange nut (□86).

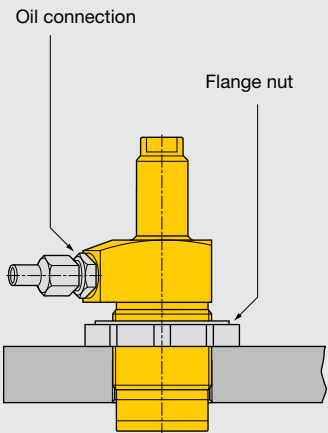

■ Threaded body pull cylinder with modified clamp arm, mounted on a frame-straightening fixture.



Threaded directly into the fixture

...can be secured at any height

- Guided linear plunger movement
- Threaded port connection
- Internal plunger thread allows easy mounting of attachments
- Simple mounting preparation
- Easy installation and removal
- Greatest flexibility in fixture design

Product selection

| Cylinder capacity | | Stroke | Model number | Cylinder effective area | | Oil capacity | |
|------------------------|--------|--------|-----------------|-------------------------|------|----------------------|------|
| lbs Pull | Push | in | | in ² Pull | Push | in ³ Pull | Push |
| ▼ Single acting | | | | | | | |
| 1250 | – | .89 | PTSS-51 | .28 | – | .25 | – |
| 2950 | – | 1.10 | PTSS-121 | .63 | – | .70 | – |
| ▼ Double acting | | | | | | | |
| 1400 | 2950 | .89 | PTSD-51 | .28 | .59 | .25 | .53 |
| 2475 | 6300 | .87 | PTSD-92 | .49 | 1.25 | .42 | 1.08 |
| 3150 | 6150 | 1.10 | PTSD-121 | .63 | 1.23 | .70 | 1.40 |
| 9600 | 18,400 | 1.20 | PTSD-351 | 1.92 | 3.68 | 2.27 | 4.35 |

Note: - Call Enerpac to order models with BSPP oil connections.
- Pull forces for single-acting cylinders reduced due to spring force.

Dimensions in inches []

| Model number | A | B | C1 | D | D1 | D2 | E |
|------------------------|------|------|------|---------------|------|------|------|
| | | | | Thread | | | Ø |
| ▼ Single acting | | | | | | | |
| PTSS-51 | 5.07 | 4.18 | 0.98 | 1.375-18 UNEF | 1.88 | 1.49 | 0.63 |
| PTSS-121 | 6.31 | 5.22 | 1.00 | 1.875-16 UN | 2.38 | 2.00 | 0.87 |
| ▼ Double acting | | | | | | | |
| PTSD-51 | 5.07 | 4.18 | 0.98 | 1.375-18 UNEF | 1.88 | 1.49 | 0.63 |
| PTSD-92 | 5.12 | 4.25 | 1.19 | M48 x 1,5 | 2.47 | 1.90 | 0.98 |
| PTSD-121 | 6.31 | 5.22 | 1.00 | 1.875-16 UN | 2.38 | 2.00 | 0.87 |
| PTSD-351 | 7.72 | 6.52 | 1.26 | 3.125-16 UN | 3.48 | 3.15 | 1.50 |

Installation dimensions in inches

| Pull force lbs | Fixture hole thread size D3 |
|----------------|-----------------------------|
| 1400 | 1.375-18 UNEF |
| 2475 | M48 x 1.5 |
| 3150 | 1.875-16 UNF |
| 9600 | 3.125-16 UN |

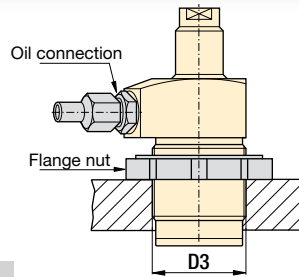

-51, 121

-92, -351

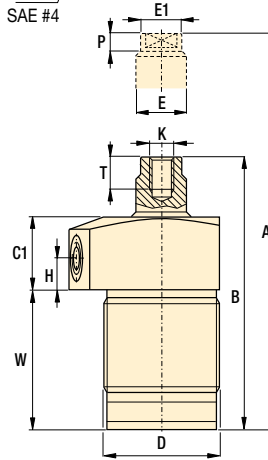
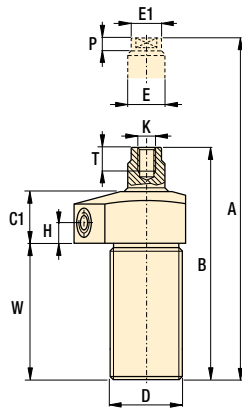
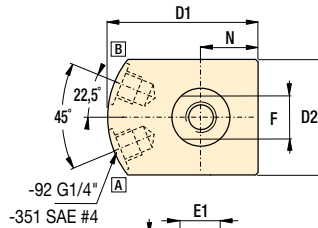
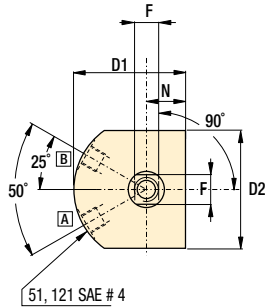

A = Pull
B = Push (venting)

Accessory chart

| Model number | Mounting flange Sold separately 87 ▶ | Flange nut Sold separately 86 ▶ | Yoke Sold separately |
|--------------|--|---------------------------------------|-------------------------|
|--------------|--|---------------------------------------|-------------------------|

▼ Single acting

| | | | |
|----------|--------|--------|-------|
| PTSS-51 | MF-351 | FN-351 | Y3121 |
| PTSS-121 | MF-481 | FN-811 | |

▼ Double acting

| | | | |
|----------|--------|--------|-------|
| PTSD-51 | MF-351 | FN-351 | Y3121 |
| PTSD-92 | MF-482 | FN-482 | |
| PTSD-121 | MF-481 | FN-481 | |
| PTSD-351 | MF-801 | FN-801 | |

| | E1 | F | H | K | N | P | T | W | lbs | Model number |
|--|------|------|-----|-------------|------|-----|------|------|------|-----------------|
| | ∅ | | | | | | | | | |
| | | | | | | | | | | Single acting ▼ |
| | .59 | .51 | .38 | .313-24 UNF | .75 | .23 | .62 | 2.60 | 2.5 | PTSS-51 |
| | .82 | .68 | .38 | .500-20 UNF | 1.00 | .38 | .75 | 3.38 | 3.5 | PTSS-121 |
| | | | | | | | | | | Double acting ▼ |
| | .59 | .51 | .38 | .313-24 UNF | .75 | .23 | .62 | 2.60 | 2.5 | PTSD-51 |
| | .93 | .70 | .51 | M10 x 1.5 | .95 | .41 | .63 | 2.47 | 4.4 | PTSD-92 |
| | .82 | .68 | .38 | .500-20 UNF | 1.00 | .38 | .75 | 3.38 | 3.5 | PTSD-121 |
| | 1.42 | 1.13 | .51 | M16 x 2.0 | 1.57 | .51 | 1.22 | 3.22 | 10.4 | PTSD-351 |

- Pull force: 1250-9600 lbs**
- Push force: 2950-18,400 lbs**
- Stroke: .87-1.20 inch**
- Pressure: 500-5000 psi**

- E** Cilindros de tracción
- F** Verins traction
- D** Zugzylinder

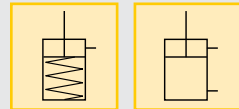

Options

- Accessories** 86 ▶
- Collet-Lok® swing cylinders** 18 ▶
- Swing cylinders** 22 ▶
- Sequence valves** 152 ▶

Important

Single-acting cylinders can be vented through the manifold port.

In case there is a risk of machining coolants and debris being inhaled via the breather vent, it is recommended to pipe this port to an area outside the fixture that is protected from machining coolants and debris.

Threaded cylinders *Application & selection*

Shown: CST-9381, CST-571, CST-18251, CDT-18131, CDT-40251



▶ Threaded cylinders are designed for workpiece positioning, holding and ejecting applications where space is at a premium. Double-acting models are also suited to manufacturing applications, such as production punching.

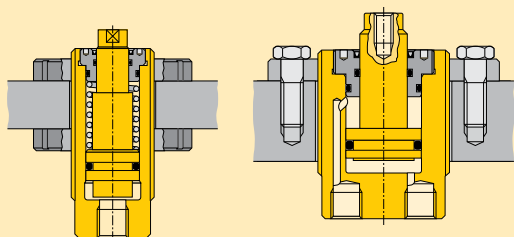

Accessory chart

| Body thread D | Mounting flange Sold Separately 87 ▶ | Flange nut Sold Separately 86 ▶ | Plunger thread K | Contact bolt Sold Separately 86 ▶ |
|------------------|--|---------------------------------------|---------------------|---|
| 0.500-20 UN | MF-121 | FN-121 | #6-32 UN | BS-21 |
| 0.750-16 UN | MF-201 | FN-201 | #8-32 UN | BS-41 |
| 1.000-12 UN | MF-251 | FN-251 | 0.250-28 UN | BS-61 |
| 1.313-16 UN | MF-331 | FN-331 | 0.313-24 UN | BS-81 |
| 1.625-16 UN | MF-421 | FN-421 | 0.375-16 UN | BS-91 |
| 1.875-16 UN | MF-481 | FN-481 | 0.500-13 UN | BS-101 |
| 2.125-16 UN | MF-551 | FN-551 | | |
| 2.500-16 UN | MF-651 | FN-651 | | |

■ Threaded cylinder, mounted with horizontal bracket to position the workpiece against the stops. Enerpac swing cylinders are then activated to clamp the work piece before machining operations begin.



High clamping forces in a compact body

- Minimum cylinder diameter combined with maximized clamping forces
- Threaded body allows fine positioning and easy installation
- Internal plunger wipers allow maintenance-free, high-cycle performance
- Center-tapped plungers will hold workpiece contact buttons
- Single-acting models with spring return simplify hydraulic tubing requirements
- Double-acting models are recommended for high-cycle applications

Product selection

| Cylinder capacity at 5000 psi lbs | Stroke in | Model number | Effective area in ² | | Oil capacity in ³ | | |
|-----------------------------------|-----------|--------------|--------------------------------|------|------------------------------|------|------|
| | | | push | pull | push | pull | |
| ▼ Single acting | | | | | | | |
| 380 | – | 0.24 | CST-271 | 0.08 | – | 0.02 | – |
| 380 | – | 0.36 | CST-2101 | 0.08 | – | 0.03 | – |
| 380 | – | 0.52 | CST-2131 | 0.08 | – | 0.04 | – |
| 980 | – | 0.27 | CST-471 | 0.20 | – | 0.05 | – |
| 980 | – | 0.50 | CST-4131 | 0.20 | – | 0.10 | – |
| 980 | – | 0.76 | CST-4191 | 0.20 | – | 0.15 | – |
| 980 | – | 0.98 | CST-4251 | 0.20 | – | 0.19 | – |
| 980 | – | 1.49 | CST-4381 | 0.20 | – | 0.29 | – |
| 1950 | – | 0.28 | CST-971 | 0.39 | – | 0.11 | – |
| 1950 | – | 0.52 | CST-9131 | 0.39 | – | 0.20 | – |
| 1950 | – | 0.76 | CST-9191 | 0.39 | – | 0.29 | – |
| 1950 | – | 1.04 | CST-9251 | 0.39 | – | 0.38 | – |
| 1950 | – | 1.52 | CST-9381 | 0.39 | – | 0.58 | – |
| 3950 | – | 0.51 | CST-18131 | 0.79 | – | 0.40 | – |
| 3950 | – | 0.98 | CST-18251 | 0.79 | – | 0.78 | – |
| 3950 | – | 1.49 | CST-18381 | 0.79 | – | 1.18 | – |
| 3950 | – | 1.97 | CST-18501 | 0.79 | – | 1.56 | – |
| 6110 | – | 0.59 | CST-27151 | 1.22 | – | 0.72 | – |
| 6110 | – | 0.98 | CST-27251 | 1.22 | – | 1.20 | – |
| 6110 | – | 1.97 | CST-27501 | 1.22 | – | 2.40 | – |
| 8800 | – | 0.58 | CST-40131 | 1.76 | – | 0.90 | – |
| 8800 | – | 1.05 | CST-40251 | 1.76 | – | 1.73 | – |
| 8800 | – | 1.56 | CST-40381 | 1.76 | – | 2.63 | – |
| 8800 | – | 2.03 | CST-40501 | 1.76 | – | 3.46 | – |
| ▼ Double acting | | | | | | | |
| 3900 | 2330 | 0.51 | CDT-18131 | 0.77 | 0.46 | 0.40 | 0.24 |
| 3900 | 2330 | 0.98 | CDT-18251 | 0.77 | 0.46 | 0.78 | 0.46 |
| 3900 | 2330 | 1.50 | CDT-18381 | 0.77 | 0.46 | 1.18 | 0.70 |
| 3900 | 2330 | 1.97 | CDT-18501 | 0.77 | 0.46 | 1.52 | 0.91 |
| 6110 | 4080 | 0.57 | CDT-27151 | 1.22 | 0.82 | 0.72 | 0.48 |
| 6110 | 4080 | 0.97 | CDT-27251 | 1.22 | 0.82 | 1.20 | 0.81 |
| 6110 | 4080 | 1.96 | CDT-27501 | 1.22 | 0.82 | 2.40 | 1.61 |
| 8800 | 5870 | 0.51 | CDT-40131 | 1.76 | 1.17 | 0.90 | 0.60 |
| 8800 | 5870 | 0.99 | CDT-40251 | 1.76 | 1.17 | 1.73 | 1.15 |
| 8800 | 5870 | 1.50 | CDT-40381 | 1.76 | 1.17 | 2.63 | 1.75 |
| 8800 | 5870 | 1.97 | CDT-40501 | 1.76 | 1.17 | 3.46 | 2.30 |

Note: - Seal material: Buna-N, Polyurethane.
- Minimum operating pressure for single-acting models (to overcome return spring force) is 580 psi.

CST-271, -2101, -2131

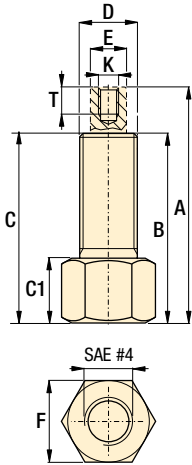

Other CST models

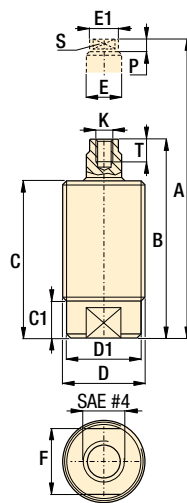

CDT models

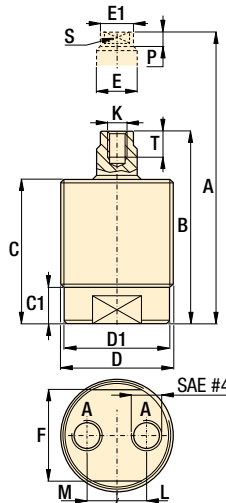

Force: 380-8800 lbs

Stroke: 0.24-2.03 inch

Pressure: 580-5000 psi

- E** Cilindros roscados
- F** Vérins corps filetés
- D** Einschraubzylinder

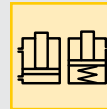

Options

Accessories

86 ▶



Product dimensions in inches []

| Model number | A Ext. height | B Retr. height | C | C1 | D ø | D1 ø | E ø | E1 ø | F | K thread | L Retr. | M Ext. | P | S | T | lbs |
|------------------------|------------------|-------------------|------|------|--------------|---------|--------|---------|------|-------------|------------|-----------|------|------|------|-----|
| ▼ Single acting | | | | | | | | | | | | | | | | |
| CST-271 | 1.89 | 1.65 | 1.61 | 0.59 | .500-20 UNF | - | 0.19 | - | 0.63 | #6-32 UNC | - | - | - | - | 0.20 | 0.2 |
| CST-2101 | 2.13 | 1.77 | 1.74 | 0.61 | .500-20 UNF | - | 0.19 | - | 0.63 | #6-32 UNC | - | - | - | - | 0.20 | 0.3 |
| CST-2131 | 2.55 | 2.03 | 2.03 | 0.61 | .500-20 UNF | - | 0.19 | - | 0.63 | #6-32 UNC | - | - | - | - | 0.20 | 0.3 |
| CST-471 | 2.14 | 1.87 | 1.71 | 0.37 | .750-16 UNF | 0.69 | 0.27 | - | 0.62 | #8-32 UNC | - | - | 0.16 | 0.25 | 0.28 | 0.4 |
| CST-4131 | 2.71 | 2.21 | 2.05 | 0.37 | .750-16 UNF | 0.69 | 0.27 | - | 0.62 | #8-32 UNC | - | - | 0.16 | 0.25 | 0.28 | 0.3 |
| CST-4191 | 3.38 | 2.62 | 2.46 | 0.37 | .750-16 UNF | 0.69 | 0.27 | - | 0.62 | #8-32 UNC | - | - | 0.16 | 0.25 | 0.28 | 0.4 |
| CST-4251 | 3.95 | 2.97 | 2.81 | 0.37 | .750-16 UNF | 0.69 | 0.27 | - | 0.62 | #8-32 UNC | - | - | 0.16 | 0.25 | 0.28 | 0.5 |
| CST-4381 | 5.76 | 4.27 | 4.11 | 0.37 | .750-16 UNF | 0.69 | 0.27 | - | 0.62 | #8-32 UNC | - | - | 0.16 | 0.25 | 0.28 | 0.7 |
| CST-971 | 2.54 | 2.26 | 2.03 | 0.32 | 1.000-12 UNF | 0.88 | 0.39 | - | 0.79 | .250-28 UNF | - | - | 0.15 | 0.32 | 0.39 | 0.6 |
| CST-9131 | 3.02 | 2.50 | 2.28 | 0.32 | 1.000-12 UNF | 0.88 | 0.39 | - | 0.79 | .250-28 UNF | - | - | 0.15 | 0.32 | 0.39 | 0.7 |
| CST-9191 | 3.87 | 3.11 | 2.89 | 0.32 | 1.000-12 UNF | 0.88 | 0.39 | - | 0.79 | .250-28 UNF | - | - | 0.15 | 0.32 | 0.39 | 0.8 |
| CST-9251 | 4.46 | 3.42 | 3.21 | 0.32 | 1.000-12 UNF | 0.88 | 0.39 | - | 0.79 | .250-28 UNF | - | - | 0.15 | 0.32 | 0.39 | 0.9 |
| CST-9381 | 5.63 | 4.11 | 3.91 | 0.32 | 1.000-12 UNF | 0.88 | 0.39 | - | 0.79 | .250-28 UNF | - | - | 0.15 | 0.32 | 0.39 | 1.0 |
| CST-18131 | 3.26 | 2.75 | 2.50 | 0.49 | 1.313-16 UN | 1.22 | 0.63 | 0.59 | 1.06 | .313-24 UNF | - | - | 0.26 | 0.50 | 0.47 | 1.2 |
| CST-18251 | 4.50 | 3.52 | 3.27 | 0.49 | 1.313-16 UN | 1.22 | 0.63 | 0.59 | 1.06 | .313-24 UNF | - | - | 0.26 | 0.50 | 0.47 | 1.3 |
| CST-18381 | 5.76 | 4.27 | 4.02 | 0.49 | 1.313-16 UN | 1.22 | 0.63 | 0.59 | 1.06 | .313-24 UNF | - | - | 0.26 | 0.50 | 0.47 | 1.5 |
| CST-18501 | 6.87 | 4.90 | 4.65 | 0.49 | 1.313-16 UN | 1.22 | 0.63 | 0.59 | 1.06 | .313-24 UNF | - | - | 0.26 | 0.50 | 0.47 | 1.7 |
| CST-27151 | 3.46 | 2.87 | 2.62 | 0.54 | 1.625-16 UN | 1.52 | 0.71 | 0.67 | 1.38 | .375-16 UNC | - | - | 0.26 | 0.57 | 0.47 | 1.4 |
| CST-27251 | 4.66 | 3.68 | 3.43 | 0.54 | 1.625-16 UN | 1.52 | 0.71 | 0.67 | 1.38 | .375-16 UNC | - | - | 0.26 | 0.57 | 0.47 | 2.0 |
| CST-27501 | 7.71 | 5.74 | 5.49 | 0.54 | 1.625-16 UN | 1.52 | 0.71 | 0.67 | 1.38 | .375-16 UNC | - | - | 0.26 | 0.57 | 0.47 | 2.9 |
| CST-40131 | 3.52 | 2.94 | 2.70 | 0.43 | 1.875-16 UN | 1.79 | 0.78 | 0.75 | 1.63 | .500-13 UNC | - | - | 0.31 | 0.67 | 0.47 | 2.2 |
| CST-40251 | 4.78 | 3.73 | 3.48 | 0.43 | 1.875-16 UN | 1.79 | 0.78 | 0.75 | 1.63 | .500-13 UNC | - | - | 0.31 | 0.67 | 0.47 | 2.6 |
| CST-40381 | 6.49 | 4.93 | 4.69 | 0.43 | 1.875-16 UN | 1.79 | 0.78 | 0.75 | 1.63 | .500-13 UNC | - | - | 0.31 | 0.67 | 0.47 | 3.3 |
| CST-40501 | 7.44 | 5.41 | 5.16 | 0.43 | 1.875-16 UN | 1.79 | 0.78 | 0.75 | 1.63 | .500-13 UNC | - | - | 0.31 | 0.67 | 0.47 | 3.9 |
| ▼ Double acting | | | | | | | | | | | | | | | | |
| CDT-18131 | 3.19 | 2.68 | 2.42 | 0.63 | 1.875-16 UN | 1.73 | 0.63 | 0.59 | 1.61 | .313-24 UNF | 0.53 | 0.39 | 0.26 | 0.50 | 0.47 | 2.4 |
| CDT-18251 | 4.21 | 3.23 | 2.97 | 0.63 | 1.875-16 UN | 1.73 | 0.63 | 0.59 | 1.61 | .313-24 UNF | 0.53 | 0.39 | 0.26 | 0.50 | 0.47 | 2.9 |
| CDT-18381 | 5.18 | 3.68 | 3.43 | 0.63 | 1.875-16 UN | 1.73 | 0.63 | 0.59 | 1.61 | .313-24 UNF | 0.53 | 0.39 | 0.26 | 0.50 | 0.47 | 3.4 |
| CDT-18501 | 6.12 | 4.15 | 3.90 | 0.63 | 1.875-16 UN | 1.73 | 0.63 | 0.59 | 1.61 | .313-24 UNF | 0.53 | 0.39 | 0.26 | 0.50 | 0.47 | 3.9 |
| CDT-27151 | 3.37 | 2.80 | 2.54 | 0.67 | 2.125-16 UN | 2.02 | 0.71 | 0.67 | 1.87 | .375-16 UNC | 0.65 | 0.39 | 0.26 | 0.62 | 0.47 | 2.6 |
| CDT-27251 | 4.20 | 3.23 | 2.97 | 0.67 | 2.125-16 UN | 2.02 | 0.71 | 0.67 | 1.87 | .375-16 UNC | 0.65 | 0.39 | 0.26 | 0.62 | 0.47 | 3.1 |
| CDT-27501 | 6.17 | 4.21 | 3.96 | 0.67 | 2.125-16 UN | 2.02 | 0.71 | 0.67 | 1.87 | .375-16 UNC | 0.65 | 0.39 | 0.26 | 0.62 | 0.47 | 4.1 |
| CDT-40131 | 3.60 | 3.09 | 2.78 | 0.70 | 2.500-16 UN | 2.38 | 0.86 | 0.83 | 2.25 | .500-13 UNC | 0.80 | 0.39 | 0.31 | 0.67 | 0.59 | 4.0 |
| CDT-40251 | 4.55 | 3.56 | 3.25 | 0.70 | 2.500-16 UN | 2.38 | 0.86 | 0.83 | 2.25 | .500-13 UNC | 0.80 | 0.39 | 0.31 | 0.67 | 0.59 | 4.6 |
| CDT-40381 | 5.57 | 4.07 | 3.76 | 0.70 | 2.500-16 UN | 2.38 | 0.86 | 0.83 | 2.25 | .500-13 UNC | 0.80 | 0.39 | 0.31 | 0.67 | 0.59 | 5.6 |
| CDT-40501 | 6.89 | 4.92 | 4.61 | 0.70 | 2.500-16 UN | 2.38 | 0.86 | 0.83 | 2.25 | .500-13 UNC | 0.80 | 0.39 | 0.31 | 0.67 | 0.59 | 6.6 |

Shown: WRT-22, CYDA-15, WMT-39



▶ **Threaded cylinders for workpiece positioning, holding and ejecting applications where space is at a premium. The advance and retract mode of double-acting models allow installation of clamping accessories to the plunger for pull and push action. Cylinders can be mounted with horizontal bracket to position the workpiece against the stops. Ideal for supporting or positioning a part.**

Fine positioning and convenient installation

...can be fixtured into manual strap or bridge clamp assemblies

- Maximum clamping force in a compact design
- Threaded body allows exact positioning and easy installation
- Center-tapped plungers allow a variety of attachments
- Single-acting spring return models simplify hydraulic tubing requirements
- Double-acting models are ideal for applications requiring powered pulling or fast automated control
- Removable base allows CYDA-15 to be threaded into a custom manifold

i Single or Double acting

Single acting

- The obvious choice when there are few system restrictions, and there are not many units retracting simultaneously
- Fewer valving requirements which results in a less complex circuit

Double acting

- Used when greater control is required during the unclamp cycle
- When timing sequences are critical
- Less sensitive to system back pressures, resulting from long tube lengths or numerous components being retracted at the same time

globe Product selection

| Cylinder capacity at maximum pressure | Stroke | | Model number | Effective area | | Oil capacity | | Operating pressure |
|---------------------------------------|--------|------|----------------|-----------------|-----------------|--------------|------|--------------------|
| | lbs | in | | in ² | in ³ | | | |
| | push | pull | | push | pull | push | pull | |
| ▼ Single acting | | | | | | | | |
| 3900 | – | .50 | WRT-21 | .79 | – | .39 | – | 150-5000 |
| 3900 | – | 1.00 | WRT-22 | .79 | – | .79 | – | 150-5000 |
| ▼ Double acting | | | | | | | | |
| 1200 | 600 | 1.56 | CYDA-15 | .41 | .20 | .62 | .31 | 150-3000 |
| 3900 | 2700 | .47 | WMT-39 | .79 | .54 | .39 | .27 | 150-5000 |
| 3900 | 2700 | .98 | WMT-40 | .79 | .54 | .79 | .54 | 150-5000 |

Note: - Seal material CYDA-15: Buna-N, Polyurethane
 - Seal material WMT and WRT series: Buna-N, Polyurethane, Teflon.

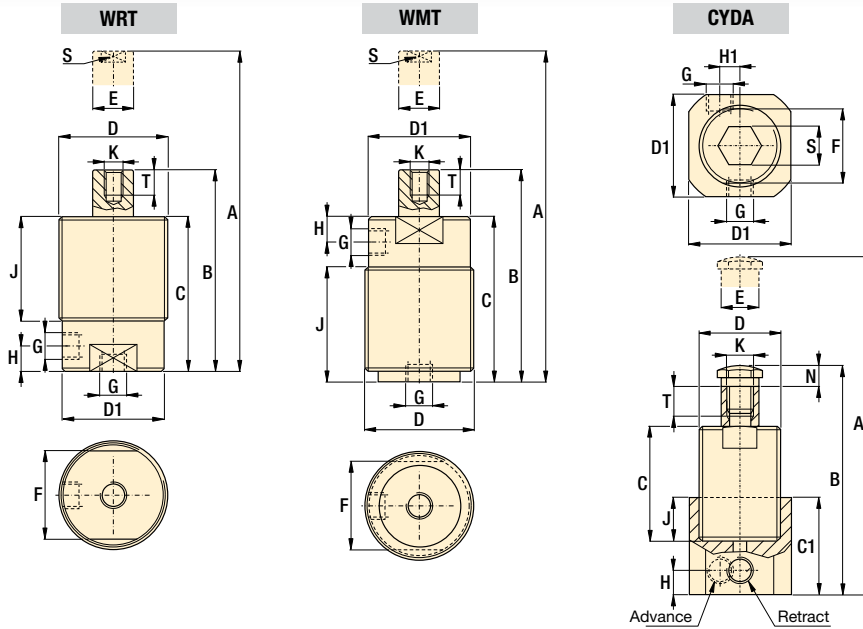

Force: 1200-3900 lbs
Stroke: .47-1.56 inch
Pressure: 150-5000 psi

- E** Cilindros roscados
- F** Vérins corps filetés
- D** Einschraubzylinder

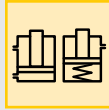

Manifold dimensions using CYDA-15 without base (Cylinder Capacity 1200 lbs)

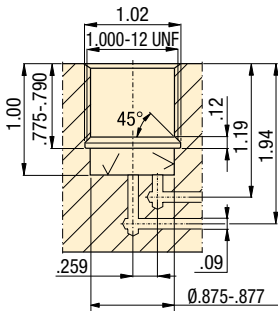

✓ Surface roughness must be 63 micro-inches

Accessory chart

| Body Thread | Mounting Flange | Flange Nut | Plunger Thread | Contact Bolt |
|-------------|---------------------------|---------------------------|----------------|---------------------------|
| D | Sold separately [87 ▶] | Sold separately [86 ▶] | K | Sold separately [86 ▶] |
| 1.000-12 UN | MF-251 | FN-251 | 0.250-28 UN | BS-61 |
| 1.375-18 UN | MF-351 | FN-351 | 0.313-24 UN | BS-81 |

Product dimensions in inches []

| Model number | A | B | C | C1 | D | D1 | E | F | G | H | H1 | J | K | N | S | T | lbs |
|------------------------|------|------|------|------|---------------|------|-----|------|-------------|-----|-----|------|---------|-----|-----|-----|-----|
| | | | | | UN | ø | ø | | | | | | UNF | | | | |
| ▼ Single acting | | | | | | | | | | | | | | | | | |
| WRT-21 | 3.75 | 3.25 | 2.95 | - | 1.375-18 UNEF | 1.23 | .75 | 1.06 | SAE #2 | .62 | - | 2.0 | .250-28 | - | .50 | .32 | 1.2 |
| WRT-22 | 4.75 | 3.75 | 3.45 | - | 1.375-18 UNEF | 1.23 | .75 | 1.06 | SAE #2 | .62 | - | 2.5 | .250-28 | - | .50 | .32 | 1.4 |
| ▼ Double acting | | | | | | | | | | | | | | | | | |
| CYDA-15 | 5.98 | 4.42 | 3.15 | 1.75 | 1.000-12 UNF | 1.25 | .50 | .87 | .125-27 NPT | .38 | .20 | 1.00 | .313-24 | .31 | .50 | .41 | 1.2 |
| WMT-39 | 3.74 | 3.27 | 2.99 | - | 1.375-18 UNEF | 1.30 | .56 | 1.06 | .125-27 NPT | .73 | - | 2.05 | .250-28 | - | .47 | .39 | 1.0 |
| WMT-40 | 4.76 | 3.78 | 3.50 | - | 1.375-18 UNEF | 1.30 | .56 | 1.06 | .125-27 NPT | .73 | - | 2.56 | .250-28 | - | .47 | .39 | 1.2 |

Options

Cylinder accessories

[86 ▶]



Important

Apply Loctite 222 or equivalent to threads and torque CYDA-15 in cavity to 72-96 in-lbs. Cavity must be designed to withstand hydraulic forces.

Manifold cylinders *Application & selection*

Shown: CSM-10131, CSM-571, CSM-18251



▶ These compact, fixture-integrated cylinders are designed for workpiece positioning, holding and ejecting applications where space is at a premium. No exposed tubing.

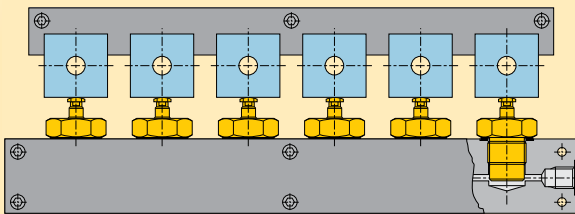

Six CSM series manifold cylinders are used to clamp piston blocks for machining. The hydraulic flow to the cylinders is side-ported in order to minimize the required manifold thickness.

■ Threaded cylinders are used here to position engine manifolds for drilling, tapping and mill finish.



Compact, fixture-integrated positioning and holding

- Design eliminates the need for fittings and tubing, minimizing space requirements and facilitating easy removal of chips and dirt
- Minimal cylinder height enables extremely compact fixture designs
- High-strength bodies and internal plunger wipers allow maintenance-free, high cycle performance
- Center-tapped plungers will hold workpiece contact buttons
- Standard SAE bodies make manifold cavity preparation easy

i Manifold mount

Manifold cylinders are designed to be screwed directly into a manifold or fixture. Enerpac's manifold cylinders feature SAE dimensions, enabling the use of standard SAE porting tools for easy cavity preparation. An SAE O-ring, included with each cylinder, provides an effective seal between the cylinder and manifold.

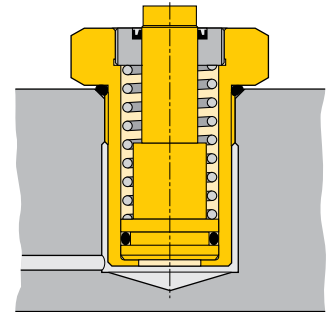

Product selection

| Cylinder capacity at 5000 psi | Stroke | Model number | Effective area | Oil capacity |
|-------------------------------|--------|------------------|-----------------|-----------------|
| | | | in ² | in ³ |
| 380 | 0.28 | CSM-271 | 0.08 | 0.02 |
| 380 | 0.51 | CSM-2131 | 0.08 | 0.04 |
| 1190 | 0.28 | CSM-571 | 0.24 | 0.07 |
| 1190 | 0.51 | CSM-5131 | 0.24 | 0.12 |
| 2590 | 0.28 | CSM-1071 | 0.50 | 0.14 |
| 2590 | 0.51 | CSM-10131 | 0.50 | 0.26 |
| 2590 | 0.75 | CSM-10191 | 0.50 | 0.38 |
| 3900 | 0.51 | CSM-18131 | 0.79 | 0.40 |
| 3900 | 0.98 | CSM-18251 | 0.79 | 0.77 |
| 6110 | 0.59 | CSM-27151 | 1.22 | 0.72 |
| 6110 | 0.98 | CSM-27251 | 1.22 | 1.20 |

Note: - Seal material: Buna-N, Polyurethane.

Collet-Lok® product line
Swing clamps
Work supports
Linear clamps

Installation dimensions in inches []

| Model number | D Thread SAE | D2 min. ϕ | H max. | J1 min. | L min. |
|--------------|------------------------|----------------|--------|---------|--------|
| CSM-271 | SAE#6 (9/16"-18 UN) | 0.97 | 0.064 | 0.50 | .96 |
| CSM-2131 | SAE#6 (9/16"-18 UN) | 0.97 | 0.064 | 0.50 | 1.45 |
| CSM-571 | SAE#10 (7/8"-14 UN) | 1.34 | 0.094 | 0.66 | 1.20 |
| CSM-5131 | SAE#10 (7/8"-14 UN) | 1.34 | 0.094 | 0.66 | 1.53 |
| CSM-1071 | SAE#12 (1-1/16"-12 UN) | 1.63 | 0.094 | 0.75 | 1.20 |
| CSM-10131 | SAE#12 (1-1/16"-12 UN) | 1.63 | 0.094 | 0.75 | 1.44 |
| CSM-10191 | SAE#12 (1-1/16"-12 UN) | 1.63 | 0.094 | 0.75 | 2.05 |
| CSM-18131 | SAE#16 (1-5/16"-12 UN) | 1.91 | 0.125 | 0.75 | 1.57 |
| CSM-18251 | SAE#16 (1-5/16"-12 UN) | 1.91 | 0.125 | 0.75 | 2.34 |
| CSM-27151 | SAE#20 (1-5/8"-12 UN) | 2.27 | 0.125 | 0.80 | 1.66 |
| CSM-27251 | SAE#20 (1-5/8"-12 UN) | 2.27 | 0.125 | 0.80 | 2.38 |

Installation dimensions

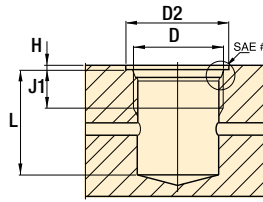

Note: - O-rings included. For additional cavity machining information, refer to SAE standards for straight internal thread, O-ring boss, or call Enerpac's Technical Service Department.

- Force: 380-6110 lbs
- Stroke: .28-.98 inch
- Pressure: 580-5000 psi

- E** Cilindros para colector
- F** Vérins pour bloc foré
- D** Einbauszylinder



Accessory chart

| Plunger Thread K | Contact Bolt \square 86 ▶ |
|------------------|-----------------------------|
| #6-32 UN | BS-21 |
| #8-32 UN | BS-41 |
| 0.313-24 UN | BS-81 |
| 0.375-16 UN | BS-91 |

CSM-271, -2131

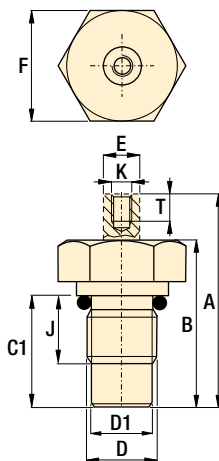

other models

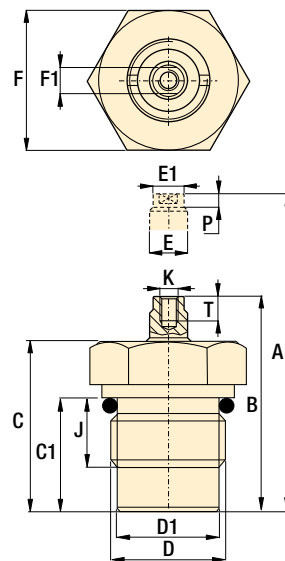

Product dimensions in inches []

| Model number | A Ext. height | B Retr. height | C | C1 | D thread | D1 ϕ | E ϕ | E1 ϕ | F | F1 | J | K thread | P | T | lbs |
|--------------|---------------|----------------|------|------|-------------|-----------|----------|-----------|------|------|------|------------|------|------|------|
| CSM-271 | 1.61 | 1.33 | - | 0.91 | .563-18 UN | 0.47 | 0.19 | - | 0.75 | - | 0.48 | #6-32 UN | - | 0.19 | 0.2 |
| CSM-2131 | 2.22 | 1.71 | - | 1.40 | .563-18 UN | 0.47 | 0.19 | - | 0.75 | - | 0.47 | #6-32 UN | - | 0.19 | 0.3 |
| CSM-571 | 2.02 | 1.74 | 1.57 | 1.14 | .875-14 UN | 0.69 | 0.31 | 0.27 | 1.06 | 0.25 | 0.55 | #8-32 UN | 0.16 | 0.28 | 0.4 |
| CSM-5131 | 2.58 | 2.07 | 1.91 | 1.48 | .875-14 UN | 0.69 | 0.31 | 0.27 | 1.06 | 0.25 | 0.55 | #8-32 UN | 0.16 | 0.28 | 0.6 |
| CSM-1071 | 2.15 | 1.87 | 1.65 | 1.14 | 1.062-12 UN | 0.94 | 0.47 | 0.43 | 1.25 | 0.35 | 0.59 | .312-24 UN | 0.22 | 0.32 | 1.1 |
| CSM-10131 | 2.65 | 2.14 | 1.89 | 1.38 | 1.062-12 UN | 0.94 | 0.47 | 0.43 | 1.25 | 0.35 | 0.59 | .312-24 UN | 0.22 | 0.31 | 1.3 |
| CSM-10191 | 3.50 | 2.75 | 2.50 | 1.99 | 1.062-12 UN | 0.94 | 0.47 | 0.43 | 1.25 | 0.35 | 0.63 | .312-24 UN | 0.22 | 0.31 | 1.4 |
| CSM-18131 | 2.87 | 2.36 | 2.11 | 1.52 | 1.312-12 UN | 1.17 | 0.63 | 0.59 | 1.61 | 0.50 | 0.79 | .312-24 UN | 0.26 | 0.47 | 1.1 |
| CSM-18251 | 4.11 | 3.13 | 2.87 | 2.28 | 1.312-12 UN | 1.18 | 0.63 | 0.59 | 1.61 | 0.50 | 0.79 | .312-24 UN | 0.26 | 0.47 | 1.3 |
| CSM-27151 | 3.13 | 2.54 | 2.31 | 1.60 | 1.625-12 UN | 1.52 | 0.71 | 0.67 | 2.17 | 0.57 | 0.79 | .375-16 UN | 0.26 | 0.47 | 1.50 |
| CSM-27251 | 4.25 | 3.27 | 3.04 | 2.33 | 1.625-12 UN | 1.52 | 0.71 | 0.67 | 2.17 | 0.57 | 0.79 | .375-16 UN | 0.26 | 0.47 | 2.00 |

Options

Accessories
Contact bolts \square 86 ▶

Important

Tighten manifold cylinders according to specifications in the instruction sheet.

Return springs in single-acting cylinders should not be used to pull back heavy attachments.

Block cylinders *Application & selection*

Shown: CDB-10162, CDB-70502, CSB-18252



▶ Block cylinders are used for punching, pressing, riveting and bending applications. In general, these cylinders are used for moving, positioning, lifting, opening and closing.

Versatile, all purpose cylinder

- Six clamping capacities enable you to choose the right size for your application
- Variety of strokes, to meet design needs
- Double acting and Single acting (spring return), allows selection of cylinder that best conforms to your hydraulic system
- Oil connection alternatives: cylinders incorporate both manifold mount and plumbed options to meet your fixturing needs
- Compact cylinder design does not require large amounts of space on your fixture
- Integral wiper ring, keeps contaminants out of cylinder to extend life

i Select your block cylinder type:

CSB series, Single acting

- Internal threaded plunger
- Manifold O-ring ports
- Black oxide base
- Hard chrome-plated plunger
- BSPP oil port
- Strong return spring
- Filtered vent plug

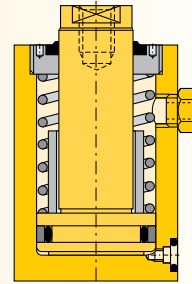

CDB series, Double acting

- Internal threaded plunger
- Manifold O-ring ports
- Black oxide base
- Hard chrome-plated plunger
- BSPP oil port

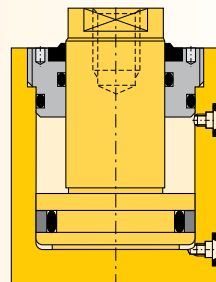

■ The versatile Enerpac block cylinders, fixture mounted for clamping applications.

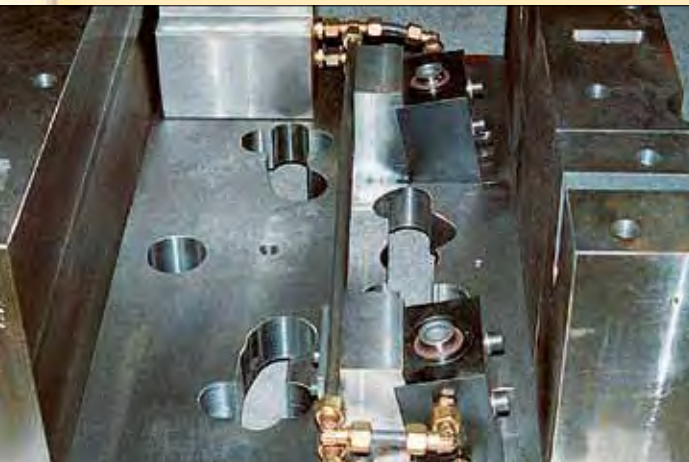

i Application example

Block cylinder positions workpiece against fixed point with further clamping coming from an Enerpac swing cylinder.

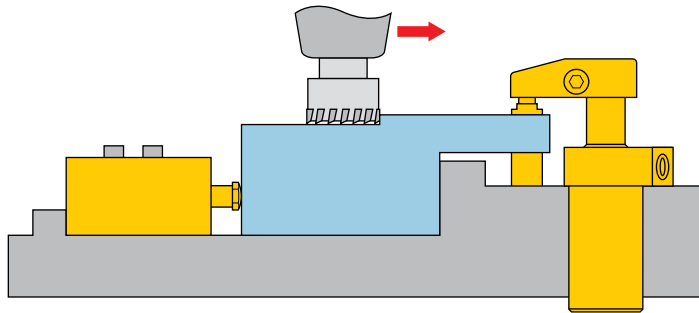

| |
|-------------------------------|
| Force: 2400-60,850 lbs |
| Stroke: .59-2.20 inch |
| Pressure: 580-5000 psi |

- E** Cilindros tipo bloque
- F** Vérins cube
- D** Blockzylinder



Accessory chart

| Plunger Thread K | Contact Bolt □86 ▶ |
|---------------------|-----------------------|
| M6 X 1,0 | BS-62 |
| M8 X 1,25 | BS-82 |
| M16 X 2,0 | BS-16 |
| M20 X 2,5 | BS-20 |
| M30 X 3,5 | BS-30 |
| M36 X 4,0 | BS-36 |

Product selection

| Piston Ø | Rod Ø | Clamping force at 5000 psi | | Stroke | Model number | Cylinder effective area | | Cylinder oil capacity | | Minimum spring return force | | |
|------------------------|-------|----------------------------|--------|--------|--------------------|-------------------------|------|-----------------------|-------|-----------------------------|------|--|
| | | push | pull | | | push | pull | push | pull | lbs | lbs | |
| in | in | lbs | | in | | in ² | | in ³ | | lbs | | |
| ▼ Single acting | | | | | | | | | | | | |
| .78 | .47 | 2400 | - | .71 | CSB-10182 | .48 | - | .35 | - | 24 | 2.6 | |
| .98 | .63 | 3800 | - | .98 | CSB-18252 | .76 | - | .75 | - | 35 | 4.0 | |
| 1.57 | .98 | 9750 | - | .98 | CSB-40252 | 1.95 | - | 1.92 | - | 85 | 5.9 | |
| 1.97 | 1.26 | 15,200 | - | .98 | CSB-70252 | 3.04 | - | 3.00 | - | 96 | 9.7 | |
| ▼ Double acting | | | | | | | | | | | | |
| .78 | .47 | 2400 | 1550 | .59 | CDB-10162 | .48 | .31 | .31 | .20 | - | 2.0 | |
| .78 | .47 | 2400 | 1550 | 1.38 | CDB-10362 | .48 | .31 | .69 | .44 | - | 2.6 | |
| .98 | .63 | 3800 | 2250 | .79 | CDB-18202 | .76 | .45 | .60 | .35 | - | 2.9 | |
| .98 | .63 | 3800 | 2250 | 1.97 | CDB-18502 | .76 | .45 | 1.50 | .90 | - | 4.0 | |
| 1.57 | .97 | 9750 | 4900 | .98 | CDB-40252 | 1.95 | .98 | 1.92 | .96 | - | 4.2 | |
| 1.57 | .97 | 9750 | 4900 | 1.97 | CDB-40502 | 1.95 | .98 | 3.83 | 1.93 | - | 5.7 | |
| 1.97 | 1.26 | 15,200 | 9000 | .98 | CDB-70252 | 3.04 | 1.80 | 3.00 | 1.77 | - | 7.1 | |
| 1.97 | 1.26 | 15,200 | 9000 | 1.97 | CDB-70502 | 3.04 | 1.80 | 5.99 | 3.54 | - | 9.5 | |
| 3.15 | 1.97 | 38,900 | 23,700 | .98 | CDB-180252 | 7.80 | 4.74 | 7.66 | 4.67 | - | 20.5 | |
| 3.15 | 1.97 | 38,900 | 23,700 | 1.97 | CDB-180502* | 7.80 | 4.74 | 15.33 | 9.34 | - | 25.4 | |
| 3.93 | 2.48 | 60,850 | 36,650 | 2.20 | CDB-280562* | 12.17 | 7.33 | 26.83 | 16.18 | - | 40.1 | |

* This product is made to order. Please contact Enerpac for delivery information before specifying in your design.

Block cylinders *Application & selection*

Shown: CDB-10162, -70502, CSB-18252



CDB, CSB series

These compact block cylinders are easily mounted in horizontal or vertical position for a range of special tooling applications.

They can be used for positioning, clamping, pushing, pressing or punching operations. The plunger has an internal thread to accommodate accessories such as contact bolts.

Block cylinder used for punching applications.



CDB-10162, -18202, -40252, -70252, -180252

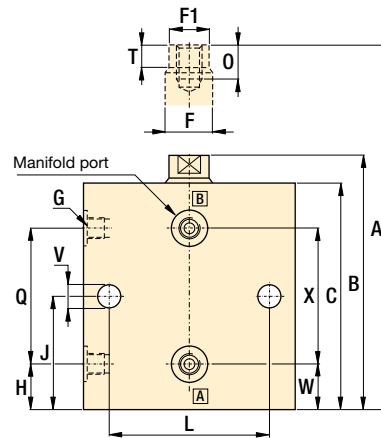
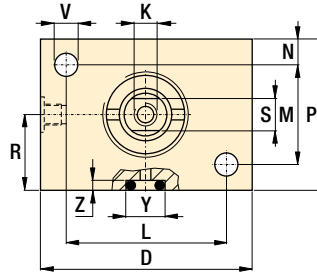

All other models

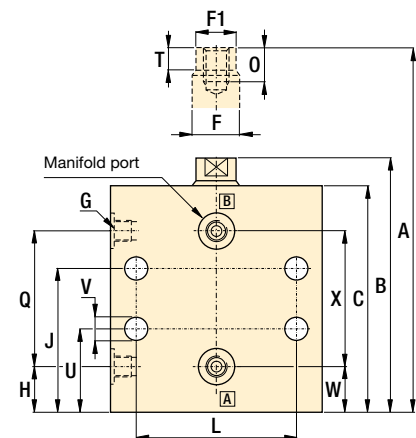
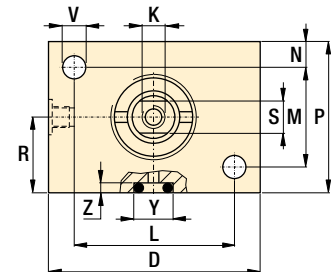

Dimensions in inches []

| Model number | A | B | C | D | F | F1 | G | H | J | K | L | M |
|-----------------|------|------|------|------|------|------|-------|-----|------|-----------|------|------|
| | | | | | ø | ø | | | | ø | | |
| ▼ Single acting | | | | | | | | | | | | |
| CSB-10182 | 3.94 | 3.23 | 2.91 | 2.36 | .47 | .43 | G1/8" | .47 | 1.75 | M6 x 1,0 | 1.77 | .98 |
| CSB-18252 | 4.92 | 3.94 | 3.62 | 2.56 | .63 | .59 | G1/8" | .47 | 2.24 | M8 x 1,25 | 1.97 | 1.18 |
| CSB-40252 | 5.13 | 4.15 | 3.66 | 3.15 | .98 | .94 | G1/8" | .39 | 2.26 | M16 x 2,0 | 2.36 | 1.38 |
| CSB-70252 | 5.63 | 4.65 | 4.09 | 3.94 | 1.26 | 1.22 | G1/4" | .54 | 2.52 | M20 x 2,5 | 3.15 | 1.77 |
| ▼ Double acting | | | | | | | | | | | | |
| CDB-10162 | 3.03 | 2.44 | 2.15 | 2.36 | .47 | .43 | G1/8" | .47 | .96 | M6 x 1,0 | 1.77 | .98 |
| CDB-10362 | 4.61 | 3.23 | 2.93 | 2.36 | .47 | .43 | G1/8" | .47 | 1.75 | M6 x 1,0 | 1.77 | .98 |
| CDB-18202 | 3.54 | 2.76 | 2.44 | 2.56 | .63 | .59 | G1/8" | .47 | 1.06 | M8 x 1,25 | 1.97 | 1.18 |
| CDB-18502 | 5.91 | 3.94 | 3.62 | 2.56 | .63 | .59 | G1/8" | .47 | 2.24 | M8 x 1,25 | 1.97 | 1.18 |
| CDB-40252 | 4.13 | 3.15 | 2.68 | 3.15 | .97 | .94 | G1/8" | .37 | 1.26 | M16 x 2,0 | 2.36 | 1.38 |
| CDB-40502 | 6.11 | 4.15 | 3.67 | 3.15 | .97 | .94 | G1/8" | .39 | 2.26 | M16 x 2,0 | 2.36 | 1.38 |
| CDB-70252 | 4.53 | 3.54 | 2.99 | 3.94 | 1.26 | 1.22 | G1/4" | .53 | 1.42 | M20 x 2,5 | 3.15 | 1.77 |
| CDB-70502 | 6.61 | 4.65 | 4.09 | 3.94 | 1.26 | 1.22 | G1/4" | .54 | 2.52 | M20 x 2,5 | 3.15 | 1.77 |
| CDB-180252 | 5.16 | 4.17 | 3.50 | 5.51 | 1.97 | 1.93 | G1/4" | .59 | 1.63 | M30 x 3,5 | 4.33 | 3.15 |
| CDB-180502* | 7.28 | 5.31 | 4.65 | 5.51 | 1.97 | 1.93 | G1/4" | .47 | 2.78 | M30 x 3,5 | 4.33 | 3.15 |
| CDB-280562* | 8.19 | 5.98 | 5.22 | 6.69 | 2.48 | 2.44 | G1/4" | .70 | 3.05 | M36 x 4,0 | 5.31 | 3.54 |

* This product is made to order. Please contact Enerpac for delivery information before specifying in your design.

i Installation instructions

When operating above 2000 psi in applications as shown in the figure below, provide cylinder back-up using a support to eliminate shear loads on the mounting bolts.

Manifold mounting

When hydraulic connections are made through the standard integrated O-ring ports as shown in figure, the sealing surface must have a roughness of 63 micro-inches.

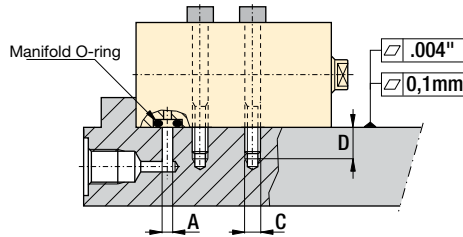

Single-acting cylinders

If the risk of machining coolants or debris being entering via the breather vent (port B) exists, it is recommended that this port be connected to a clean, remote termination point.

A Installation dimensions in inches [\varnothing]

| Clamping capacity | Oil channel diameter | Mounting thread | Min. thread length | Torque (bolt type 12.9 DIN 912) | Manifold O-ring ¹⁾ | |
|-------------------|----------------------|-----------------|--------------------|---------------------------------|-------------------------------|---------|
| | | | | | Inside Ø x thickness | ARP No. |
| lbs | A | mm C | D | Ft.lbs | | |
| 2400 | .20 | M6 | .43 | 13 | .31 x .06 | 568-011 |
| 3800 | .20 | M8 | .51 | 30 | .31 x .06 | 568-011 |
| 9750 | .20 | M10 | .63 | 63 | .31 x .06 | 568-011 |
| 15,200 | .20 | M12 | .75 | 107 | .31 x .06 | 568-011 |
| 38,900 | .31 | M16 | .94 | 260 | .38 x .09 | 568-110 |
| 60,850 | .31 | M20 | 1.10 | 498 | .38 x .09 | 568-110 |

¹⁾ Manifold O-rings included

| N | O | P | Q | R | S | T | U | V | W | X | Y | Z | Model number |
|------|------|------|------|------|------|-----|------|-----|-----|------|-----|-----|------------------------|
| min. | | | | | | | | | | | | | |
| | | | | | | | | | | | | | Single acting ▼ |
| .30 | .39 | 1.57 | 1.77 | .79 | .35 | .22 | .96 | .27 | .47 | 1.77 | .44 | .05 | CSB-10182 |
| .30 | .49 | 1.77 | 2.36 | .89 | .51 | .24 | 1.06 | .35 | .47 | 2.36 | .44 | .05 | CSB-18252 |
| .39 | .98 | 2.17 | 2.46 | 1.08 | .87 | .37 | 1.07 | .42 | .39 | 2.46 | .44 | .05 | CSB-40252 |
| .41 | 1.18 | 2.60 | 2.63 | 1.30 | 1.06 | .43 | 1.15 | .49 | .60 | 2.57 | .44 | .05 | CSB-70252 |
| | | | | | | | | | | | | | Double acting ▼ |
| .30 | .39 | 1.57 | .98 | .79 | .35 | .22 | – | .27 | .47 | .98 | .44 | .05 | CDB-10162 |
| .30 | .39 | 1.57 | 1.77 | .79 | .35 | .22 | .96 | .27 | .47 | 1.77 | .44 | .05 | CDB-10362 |
| .30 | .49 | 1.77 | 1.18 | .89 | .51 | .24 | – | .35 | .47 | 1.18 | .44 | .05 | CDB-18202 |
| .30 | .49 | 1.77 | 2.36 | .89 | .51 | .24 | 1.06 | .35 | .47 | 2.36 | .44 | .05 | CDB-18502 |
| .39 | .98 | 2.17 | 1.48 | 1.08 | .87 | .37 | – | .42 | .37 | 1.48 | .44 | .05 | CDB-40252 |
| .39 | .98 | 2.17 | 2.46 | 1.08 | .87 | .37 | 1.07 | .42 | .39 | 2.46 | .44 | .05 | CDB-40502 |
| .41 | 1.18 | 2.60 | 1.54 | 1.30 | 1.06 | .43 | – | .49 | .49 | 1.57 | .44 | .05 | CDB-70252 |
| .41 | 1.18 | 2.60 | 2.63 | 1.30 | 1.06 | .43 | 1.15 | .49 | .60 | 2.57 | .44 | .05 | CDB-70502 |
| .59 | 1.77 | 4.33 | 1.79 | 2.17 | 1.61 | .57 | – | .67 | .61 | 1.77 | .56 | .07 | CDB-180252 |
| .59 | 1.77 | 4.33 | 3.05 | 2.17 | 1.61 | .57 | 1.20 | .67 | .77 | 2.76 | .56 | .07 | CDB-180502* |
| .69 | 1.97 | 4.92 | 3.16 | 2.46 | 1.97 | .67 | 1.48 | .83 | .71 | 3.15 | .56 | .07 | CDB-280562* |

* This product is made to order. Please contact Enerpac for delivery information before specifying in your design.

Force: 2400-60,850 lbs

Stroke: .59-2.20 inch

Pressure: 580-5000 psi

- E** Cilindros tipo bloque
- F** Vérins cube
- D** Blockzylinder

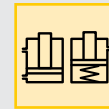



! Important

Linear cylinder support is required at operating pressures above 2000 psi. Follow the instructions on this page.

💡 Options

Contact bolts  [86](#)

Fittings  [194](#)

Pressure gauges  [190](#)

High pressure filters  [193](#)

Linear cylinders
Power sources
Valves
Pallet components
System components
Yellow pages

Pull down clamps *Application & selection*

Shown: ECM-20, ECH-202, ECM-5, ECH-52



Enerpac pull down clamps are designed to allow unobstructed top face machining. Independent horizontal and vertical movement achieves high lateral and pull down forces to hold the workpiece firmly down against the machine table or fixture. The pull down forces are approximately 33% of the clamping force.

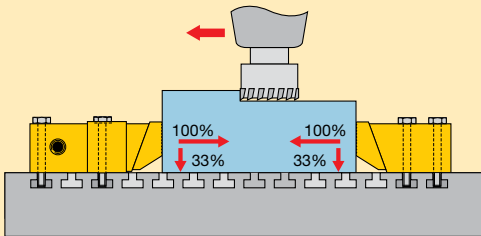

The pull down clamps can be permanently mounted using the supplied mounting bolts. Optional T-nuts can be used for adapting to varying workpiece sizes.

■ Enerpac hydraulic pull down clamps and their mechanical counter parts used to manufacture tie-rod cylinder end caps.



Low profile clamp

.....for unobstructed top face machining

- Independent horizontal and vertical movement for a true pull down effect
- Compact size and low height allows more flexible and economic mounting than comparable dedicated vise
- Manifold and BSPP porting
- Investment high-alloy cast, heat-treated clamping jaw and plunger
- Contamination resistant design for low maintenance, removable guard for chip removal
- Oil ports on both sides for mounting flexibility
- Optional mechanical counter hold provides pull down on end stop for large parts
- Mounting bolts included for ease of installation

i Pull down clamp operation

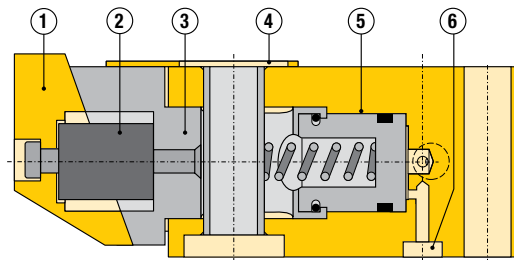

The moveable jaw ① and the flexible connection design ② allows lateral movement and eliminate any bending moment. Roller finished cylinder bore ③ improves seal life. The removable guard ④ prevents the entry of chips and allows easy cleaning. Heat treated, centerless ground plunger ⑤ for extremely close tolerances and long life. The clamps feature both manifold mount ⑥ and plumbed oil connection.

globe Product selection

| Lateral clamping force at 5000 psi | Pull down force at 5000 psi | Stroke | Model number | Effective area | Oil capacity | Mounting bolts ¹⁾ (included) |
|------------------------------------|-----------------------------|--------|----------------|-----------------|-----------------|---|
| lbs | lbs | in | | in ² | in ³ | mm |
| 870 | 290 | .20 | ECH-52 | .18 | .03 | M8 x 45 |
| 3900 | 1300 | .31 | ECH-202 | .78 | .24 | M12 x 80 |

| Holding force | For pull down clamp model number | Model number | Mounting bolts included ¹⁾ number | Replaceable ribbed jaws model |
|---------------|----------------------------------|---------------|--|-------------------------------|
| lbs | | | mm | |
| 870 | ECH-52 | ECM-5 | M8 x 35 | ECJR-5 |
| 3900 | ECH-202 | ECM-20 | M12 x 65 | ECJR-20 |

¹⁾ Torque M8 with 18 Ft.lbs, M12 with 63 Ft.lbs. The use of T-nuts requires longer bolts.

Collet-Lok® product line
Swing clamps
Work supports
Linear clamps

i Pull down force

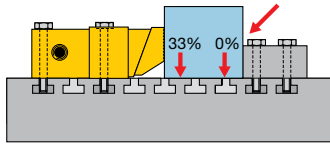

Fixed stop set-up

A very workable set-up for workpieces that are not larger or wider than twice the width of the edge clamp. The pull down force of the hydraulic actuated edge clamp is sufficient to pull down and hold the product during actual machining.

The mounting surface must extend out under the jaw.

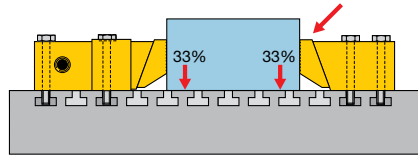
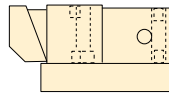

Counter hold set-up

For workpieces larger than twice the width of the edge clamp used, it is recommended to install a mechanical counter hold. The counter hold also produces a pull down force equal to 1/3 of the lateral force of the hydraulic edge clamp applied. In this way the grip on the workpiece is very tight. Another advantage of this set-up is the repeated accuracy of machining results.

ECH-52, -202

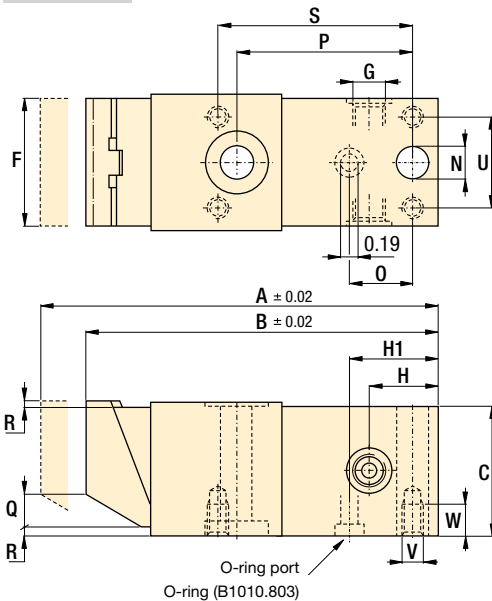

ECM-5, -20

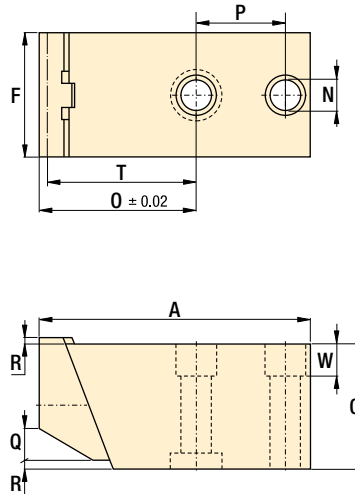

A Product dimensions in inches [\varnothing]

| Model number | A | B | C | F | G | H | H1 | N | O | P | Q | R | S | T | U | V | W | lbs |
|-------------------------------------|------|------|------|------|-------|-----|-----|-----|------|------|-----|-----|------|------|------|-----------|-----|-----|
| | mm | | | | | | | | | | | | | | | | | |
| ▼ Hydraulic pull down clamps | | | | | | | | | | | | | | | | | | |
| ECH-52 | 4.14 | 3.94 | 1.18 | 1.18 | G1/8" | .75 | .74 | .33 | .46 | 2.09 | .12 | .08 | 2.32 | - | .87 | M5 x 0,8 | .24 | 1.5 |
| ECH-202 | 5.62 | 5.31 | 1.97 | 1.97 | G1/4" | .98 | .93 | .49 | .54 | 2.64 | .55 | .12 | 2.91 | - | 1.42 | M8 x 1,25 | .47 | 5.5 |
| ▼ Mechanical counter holds | | | | | | | | | | | | | | | | | | |
| ECM-5 | 3.11 | - | 1.18 | 1.18 | - | - | - | .33 | 1.65 | 1.02 | .12 | .08 | - | 1.61 | - | - | .31 | 1.3 |
| ECM-20 | 4.02 | - | 1.97 | 1.97 | - | - | - | .49 | 2.36 | 1.18 | .55 | .12 | - | 2.32 | - | - | .51 | 4.1 |

- Force: 870-3900 lbs
- Stroke: .20-.31 inch
- Pressure: 225-5000 psi
- E** Garras de empuje oblicuo
- F** Crampons plaqueurs
- D** Niederzugspanner

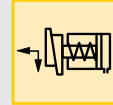

i Options

- Fittings** 194 ▶
- Threaded cylinders** 66 ▶
- Positive clamping cylinders** 80 ▶

! Important

Do not allow the clamping jaw to extend below the lower surface of the clamp body.

Linear cylinders Power sources Valves Pallet components System components Yellow pages

Hollow plunger cylinders *Application & selection*

Shown: HCS-20, RWH-121, RWH-202



▶ These cylinders are regularly used for upgrading mechanical clamping to faster and easier hydraulic clamping. Other typical applications include production pressing, punching and crimping operations.

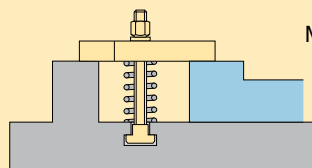

Mechanical set-up

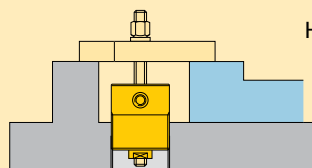

Hydraulic set-up

Traditional mechanical elements in a clamping fixture are replaced by a hollow plunger hydraulic cylinder.

■ Two Enerpac RWH-121 hollow cylinders mounted at the back side of a fixture.

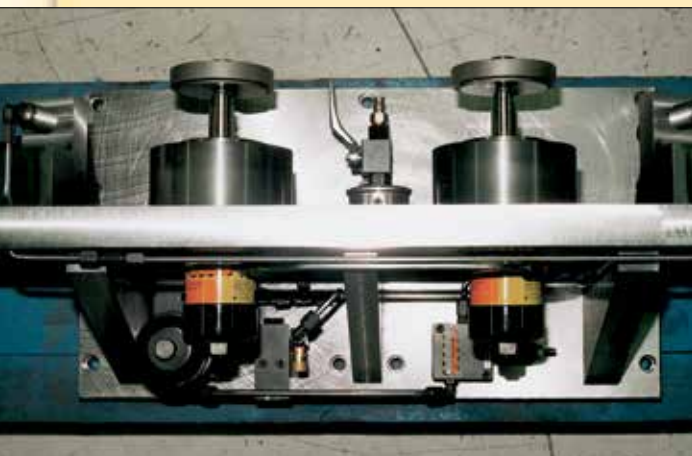

For high force push and pull applications on and around the fixture

- Load can be attached to either end of the cylinder, providing a choice of push or pull actions - both realizing full cylinder capacity
- Very high cylinder capacities contained within small dimensions allow compact fixture designs
- Spring return operation allows for easy unloading of the workpiece
- Threaded collars and base mounting holes allow mounting flexibility, including table-top surfaces and T-slots
- Nickel-plated plungers, plunger wipers and internal venting prevent corrosion and support longer operation life on all HCS models
- The CY series hollow plunger cylinders can be manifold mounted (except for CY-1254-25)

Product selection

| Cylinder capacity ¹⁾ | Stroke | Center hole diameter | Model number | Effective area | Oil capacity | Operating pressure |
|---------------------------------|--------|----------------------|-------------------------------|-----------------|-----------------|--------------------|
| | | | | in ² | in ³ | psi |
| 2610 | 0.25 | 0.39 | CY1254-25 | 0.87 | 0.22 | 3000 |
| 4000 | 0.33 | 0.53 | MRH-20 | 1.33 | 0.41 | 3000 |
| 4000 | 0.33 | 0.53 | RWH-20 | 1.33 | 0.41 | 3000 |
| 4000 | 0.33 | 0.53 | RWH-20T | 1.33 | 0.41 | 3000 |
| 4830 | 0.40 | 0.42 | HCS-20* | 0.96 | 0.38 | 5000 |
| 7410 | 0.31 | 0.77 | CY2129-25¹⁾ | 2.47 | 0.77 | 3000 |
| 7410 | 0.63 | 0.77 | CY2129-5¹⁾ | 2.47 | 1.56 | 3000 |
| 12,660 | 0.48 | 0.51 | HCS-50* | 2.52 | 1.19 | 5000 |
| 13,320 | 0.63 | 0.89 | CY2754-5 | 4.44 | 2.80 | 3000 |
| 13,800 | 0.32 | 0.77 | MRH-120 | 2.76 | 0.86 | 5000 |
| 13,800 | 0.32 | 0.77 | QDH-120 | 2.76 | 0.86 | 5000 |
| 13,800 | 0.32 | 0.77 | RWH-120 | 2.76 | 0.86 | 5000 |
| 13,800 | 1.02 | 0.77 | RWH-121 | 2.76 | 2.76 | 5000 |
| 18,180 | 0.56 | 0.67 | HCS-80* | 3.63 | 1.99 | 5000 |
| 23,500 | 0.52 | 1.06 | RWH-200 | 4.74 | 2.37 | 5000 |
| 23,500 | 2.02 | 1.06 | RWH-202 | 4.74 | 9.48 | 5000 |
| 25,490 | 0.63 | 0.83 | HCS-110* | 5.06 | 3.19 | 5000 |
| 36,000 | 0.50 | 1.31 | RWH-300 | 7.22 | 3.60 | 5000 |
| 36,000 | 1.00 | 1.31 | RWH-301 | 7.22 | 7.22 | 5000 |
| 36,000 | 2.49 | 1.31 | RWH-302 | 7.22 | 18.00 | 5000 |

¹⁾ At maximum operating pressure. **Note:** Seal material Buna-N, Polyurethane, Teflon.

* This product is made to order. Please contact Enerpac for delivery information before specifying in your design.

i Optional Heat Treated Hollow Saddles

| Saddle type | Cylinder model number | Saddle model No. | Saddle Dimensions (in) | | |
|-----------------|-----------------------|------------------|------------------------|--------|-----|
| | | | A | B | C |
| Threaded hollow | RWH-200, 202 | HP-2015 | 2.11 | 1 - 8 | .38 |
| | RWH-300, 301, 302 | HP-3015 | 2.49 | 1¼ - 7 | .38 |

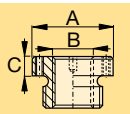

Smooth hollow saddles are standard on all RWH 20 and 30 ton models (12 ton models are not equipped with saddles).

MRH-20, 120

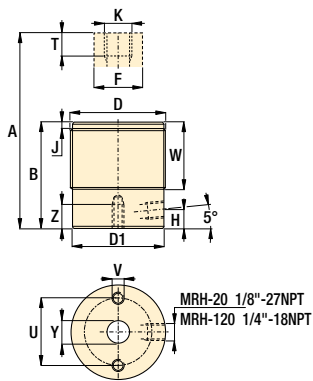

RWH-20, 120, 121, QDH-20

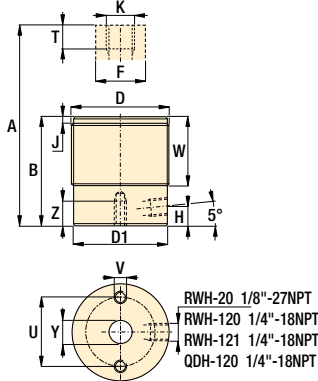

other RWH model

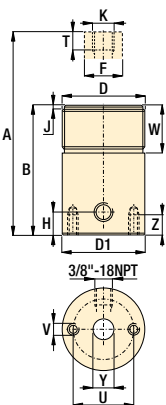

CY models

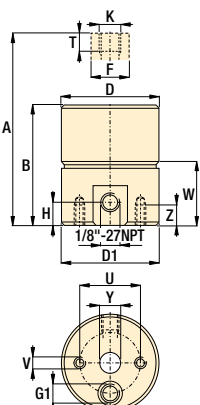

HCS models

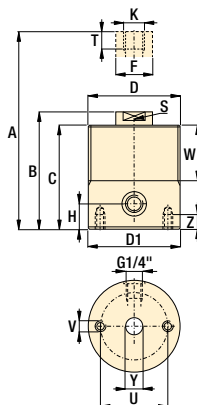

A Product dimensions in inches []

| Model number | A | B | C | D | D1 | F | H | J | K | S | T | U | V | W | Y | Z | lbs |
|-------------------------------|------|------|------|-------------|------|------|------|------|-------------|------|------|------|-------------|------|-------------|------|------|
| CY1254-25 | 2.25 | 2.00 | - | Ø 1.75 | 1.75 | 0.56 | 0.29 | - | .375-16 UNC | - | 0.62 | 1.25 | .250-20 UNC | 0.97 | Ø 0.39 | 0.38 | 1.0 |
| MRH-20 | 2.39 | 2.06 | - | M48 X 1.5 | 1.77 | 1.00 | 0.28 | 0.12 | Ø .53 | - | 0.88 | 1.38 | M6 X 1.0 | 1.50 | Ø 0.50 | 0.25 | 1.3 |
| RWH-20 | 2.39 | 2.06 | - | 1.875-16 UN | 1.79 | 1.00 | 0.28 | 0.12 | Ø .53 | - | 0.87 | 1.38 | .250-20 UNC | 1.50 | .500-20 UNF | 0.25 | 1.4 |
| RWH-20T | 2.39 | 2.06 | - | 1.875-16 UN | 1.79 | 1.00 | 0.28 | 0.12 | .500-20 UNF | - | 0.49 | 1.38 | .250-20 UNC | 1.50 | Ø 0.53 | 0.25 | 1.4 |
| HCS-20 | 3.43 | 2.93 | 2.60 | M58 X 1.5 | 2.28 | 0.71 | 0.43 | - | M10 X 1.5 | 0.55 | 1.01 | 1.57 | M6 X 1.0 | 1.57 | Ø 0.42 | 0.39 | 2.4 |
| CY2129-25¹⁾ | 2.31 | 2.00 | - | Ø 2.63 | 2.50 | 1.13 | 0.31 | - | .750-10 UNC | - | 1.13 | 1.75 | .375-16 UNC | 0.80 | Ø 0.77 | 0.34 | 2.5 |
| CY2129-5¹⁾ | 3.36 | 2.73 | - | Ø 2.63 | 2.50 | 1.13 | 0.31 | - | .750-10 UNC | - | 1.13 | 1.75 | .375-16 UNC | 1.54 | Ø 0.77 | 0.44 | 3.0 |
| HCS-50 | 3.80 | 3.32 | 2.95 | M65 X 1.5 | 2.56 | 1.10 | 0.55 | - | M12 X 1.75 | 0.87 | 0.95 | 1.77 | M8 X 1.25 | 1.77 | Ø 0.51 | 0.47 | 3.3 |
| CY2754-5 | 3.63 | 3.00 | - | Ø 3.5 | 3.13 | 1.25 | 0.44 | - | .875-9 UNC | - | 1.25 | 2.12 | .375-16 UNC | 1.61 | Ø 0.89 | 0.44 | 6.0 |
| MRH-120 | 2.54 | 2.20 | - | M70 X 1.5 | 2.76 | 1.38 | 0.39 | 0.19 | M18 X 1.5 | - | 0.60 | 2.00 | M6 X 1.0 | 0.68 | Ø 0.77 | 0.25 | 3.1 |
| QDH-120 | 2.54 | 2.22 | - | 2.750-16 UN | 2.75 | 1.38 | 0.39 | 0.19 | .750-10 UNC | - | 0.62 | 2.00 | .312-18 UNC | 0.68 | Ø 0.77 | 0.25 | 3.0 |
| RWH-120 | 2.54 | 2.22 | - | 2.750-16 UN | 2.75 | 1.38 | 0.39 | 0.19 | .750-16 UNF | - | 0.61 | 2.00 | .312-18 UNC | 0.68 | Ø 0.77 | 0.25 | 3.1 |
| RWH-121 | 4.24 | 3.22 | - | 2.750-16 UN | 2.75 | 1.38 | 0.53 | 0.19 | .750-16 UNF | - | 0.73 | 2.00 | .312-18 UNC | 0.68 | Ø 0.77 | 0.25 | 4.8 |
| HCS-80 | 4.31 | 3.75 | 3.35 | M75 X 1.5 | 2.95 | 1.26 | 0.67 | - | M16 X 2.0 | 0.94 | 1.27 | 2.17 | M8 X 1.25 | 1.97 | Ø 0.67 | 0.47 | 5.1 |
| RWH-200 | 5.39 | 4.88 | - | 3.875-12 UN | 3.88 | 2.12 | 0.75 | 0.19 | Ø 1.06 | - | 0.88 | 3.25 | .375-16 UNC | 1.50 | Ø 1.06 | 0.38 | 13.6 |
| RWH-202 | 8.39 | 6.37 | - | 3.875-12 UN | 3.88 | 2.12 | 0.75 | 0.19 | Ø 1.06 | - | 0.88 | 3.25 | .375-16 UNC | 1.50 | Ø 1.06 | 0.38 | 17.0 |
| HCS-110 | 4.74 | 4.11 | 3.66 | M90 X 2.0 | 3.54 | 1.57 | 0.75 | - | M20 X 2.5 | 1.26 | 1.44 | 2.56 | M10 X 1.5 | 2.36 | Ø 0.83 | 0.59 | 7.9 |
| RWH-300 | 5.52 | 5.02 | - | 4.500-12 UN | 4.49 | 2.54 | 0.85 | 0.19 | Ø 1.31 | - | 0.88 | 3.62 | .375-16 UNC | 1.66 | Ø 1.31 | 0.62 | 19.0 |
| RWH-301 | 6.52 | 5.52 | - | 4.500-12 UN | 4.49 | 2.54 | 0.85 | 0.19 | Ø 1.31 | - | 0.88 | 3.62 | .375-16 UNC | 1.66 | Ø 1.31 | 0.62 | 21.5 |
| RWH-302 | 9.52 | 7.03 | - | 4.500-12 UN | 4.49 | 2.54 | 0.85 | 0.19 | Ø 1.31 | - | 0.88 | 3.62 | .375-16 UNC | 1.66 | Ø 1.31 | 0.62 | 24.0 |

¹⁾ For these models G1 = manifold and .125-27 NPTF

Force: 2610-36,000 lbs

Stroke: .25-2.49 inch

Pressure: 800-5000 psi

- E** Cilindros de émbolo hueco
- F** Vérins a piston creux
- D** Hohlkolbenzylinder

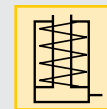

i Options

Flange nuts

86 ▶

! Important

Use Grade 8 (DIN12.9) bolt quality or better for pulling. Use Grade B7 (DIN10.9) threaded rod quality or better for pulling applications.

RWH cylinders can be used up to 10,000 psi maximum working pressure (except RWH-20 and RWH120).

Positive clamping cylinder *Application & selection*

Shown: MRS-1, MRS-1001, MRS-5001



▶ These cylinders are designed for prolonged clamping applications in moveable machine parts, tools, fixtures, pallets and workpieces.

The mechanical clamping force of this cylinder is ideal for FMS applications. Hydraulic pressure is used to release the workpiece and is not required to maintain the clamping force on the workpiece. Internal high strength springs produce the required clamping force.

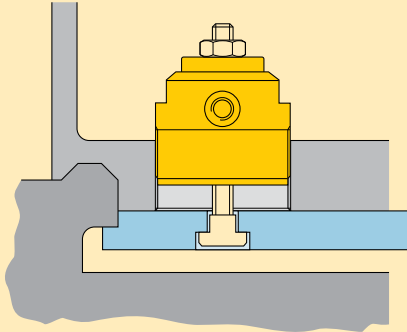

■ When pressure is released, the Enerpac MRS cylinders clamp the workpiece by pushing it against the frame that is attached to the fixture.

Ideal for palletized applications

- Heavy disk springs maintain the clamping force - hydraulic pressure is used for release
- Single-acting design allows easy setup of hydraulic system
- Hollow plunger design allows easy retrofit for mechanical clamping
- Custom buttons can be fitted into the plunger for clamping directly against a workpiece
- Threaded body allows easy cylinders mounting directly into fixture plate
- Internal threaded plunger allows accessories to be used easily for retrofit applications

i Positive clamping operation

The applied clamping force is determined by how far the cylinder's plunger is being retracted when engaging contact with the workpiece (referred to as the effective clamping stroke).

Use the diagrams on the next page as a guide to your fixture set-up. Note that in order to load and unload the workpiece, the plunger must be retracted somewhat further than the effective clamping stroke.

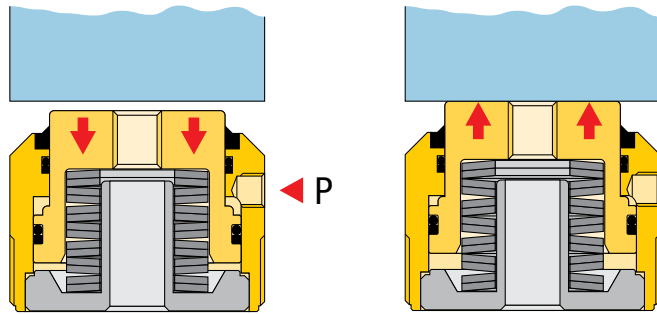

Hydraulic pressure applied

- Plunger retracts
- Work piece is released
- New work piece is loaded

Hydraulic pressure released

- Springs apply force
- Workpiece is clamped
- Machining can take place

Product selection

| Cylinder capacity at 5000 psi | Effective clamping stroke | Model number | Required operating pressure ¹⁾ | Max. tensioning stroke | Oil capacity |
|-------------------------------|---------------------------|-----------------|---|------------------------|-----------------|
| lbs | in | | psi | in | in ³ |
| 2700 | .09 | MRS-1 | 5000 | .09 | .05 |
| 6000 | .09 | MRS-2 | 5000 | .09 | .26 |
| 11,500 | .09 | MRS-5 | 5000 | .09 | .50 |
| 1900 | .10 | MRS-1001 | 2000 | .20 | .54 |
| 3700 | .10 | MRS-2001 | 2700 | .20 | .73 |
| 5800 | .10 | MRS-3001 | 2600 | .20 | 1.22 |
| 8500 | .12 | MRS-5001 | 3400 | .22 | 1.35 |

¹⁾ Minimum operating pressure to fully retract the plunger.
Note: Seal material Buna-N, Polyurethane.

Collet-Lok® product line
Swing clamps
Work supports
Linear clamps

Stroke/force diagrams for MRS-1001, -2001, -3001, -5001

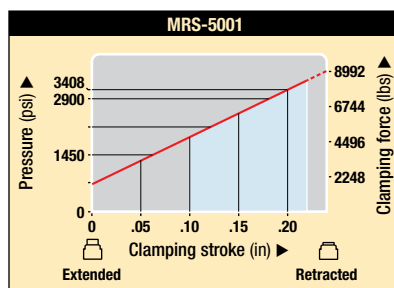
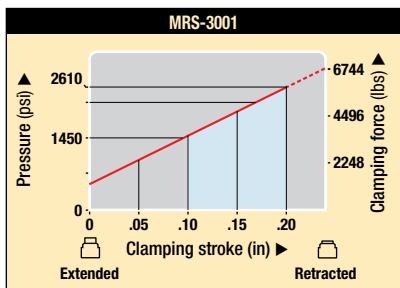
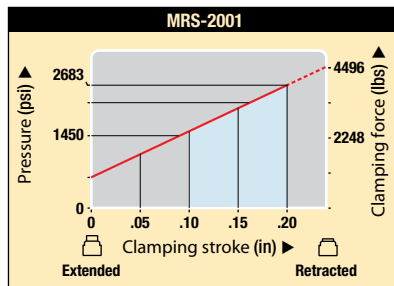
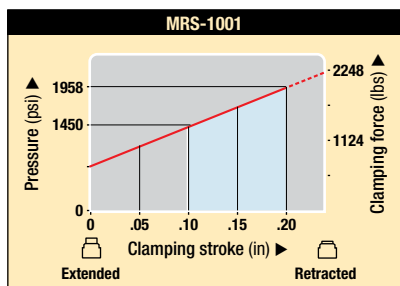

■ = Suggested Clamping Range

MRS-1, 2, 5

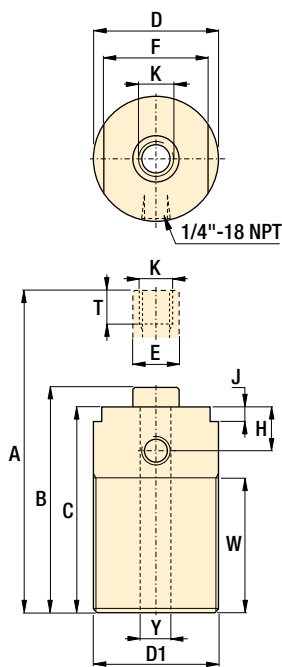

other MRS models

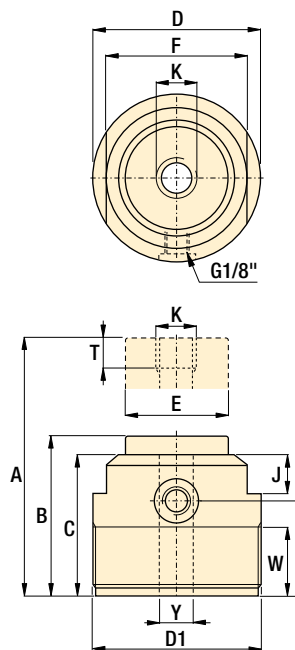

Product dimensions in inches []

| Model number | A | B | C | D | D1 | E | F | H | J | K | T | W | Y | lbs |
|--------------|------|------|------|------|-----------|------|------|------|-----|------------|------|------|-----|-----|
| | | | | | | | | | | | | | | |
| MRS-1 | 3.35 | 3.26 | 3.11 | 1.42 | M36 x 1,5 | .50 | 1.18 | .71 | .24 | M8 x 1,25 | 1.42 | 1.97 | .35 | 1.1 |
| MRS-2 | 3.54 | 3.46 | 3.31 | 1.89 | M48 x 1,5 | .68 | 1.57 | .79 | .28 | M10 x 1,50 | 1.50 | 1.97 | .43 | 2.0 |
| MRS-5 | 4.92 | 4.83 | 4.69 | 2.36 | M60 x 2,0 | .87 | 1.97 | .83 | .28 | M16 x 2,0 | 1.57 | 3.35 | .67 | 4.0 |
| MRS-1001 | 2.44 | 2.24 | 2.09 | 2.56 | M65 x 1,5 | 1.57 | 2.17 | 1.38 | .59 | M12 x 1,75 | .79 | .98 | .51 | 2.6 |
| MRS-2001 | 2.56 | 2.36 | 2.24 | 3.15 | M80 x 2,0 | 2.16 | 2.56 | 1.50 | .59 | M16 x 2,0 | .79 | 1.14 | .67 | 4.6 |
| MRS-3001 | 2.91 | 2.72 | 2.60 | 3.74 | M95 x 2,0 | 2.36 | 3.15 | 1.81 | .67 | M20 x 2,5 | .79 | 1.46 | .83 | 6.6 |
| MRS-5001 | 3.78 | 3.56 | 2.66 | 3.74 | M95 x 2,0 | 2.36 | 3.15 | 1.81 | .67 | M20 x 2,5 | .79 | 1.46 | .83 | 7.7 |

- Force: 1900-11,500 lbs
- Stroke: .09-.22 inch
- Pressure: 2000-5000 psi

- E** Cilindros de amarre
- F** Vérins de bridage positif
- D** Federspannzylinder



Options

Contact bolts 86 ▶

Flange nuts 86 ▶

Collet-Lok® work supports 16 ▶

Important

Be sure to refer to the force/stroke chart when selecting cylinders for an application. Piece parts with a large variation at the clamping point may be prone to having variations in clamping force.

Depending on the cycle usage of the application and amount of deflection, the internal disk springs may need to be replaced at scheduled intervals.

Universal cylinders - Single acting *Application & selection*

Shown: RW-50, RW-104



Used when high cylinder forces or long strokes are required in a confined area. Can handle a wide range of production tooling applications.

Block and cylindrical models

Cylindrical models

- Long stroke
- Flexible in fixture design
- Variety of attachments

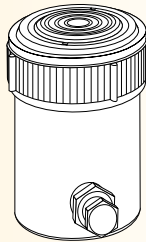

Block models

- Easily mounted
- Compact design

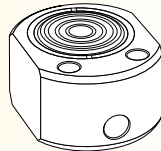

Enerpac RW-101 cylinders used in a high pressure toggle style clamping set-up.



Heavy-duty cylinders

...handle a variety of applications

- High pressure design when additional force is required
- Long stroke lengths in a compact design, well suited for welding applications
- Collar mounting threads and base mounting holes allow flexible mounting options
- Cylinders are provided with hardened saddles for additional plunger protection
- Snap-in saddles are easily removed for adapting to different plunger devices
- Chrome plated plunger with bronze upper and lower bearing provides a long cylinder life

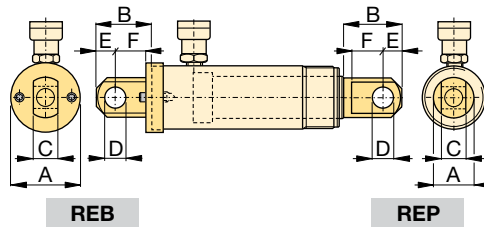

| Type | Model number | Clevis eye dimensions (in) | | | | | | Pin to pin* in |
|--------------------|--------------|----------------------------|------|------|-----|------|------|-------------------|
| | | A | B | C | D | E | F | |
| Base ¹⁾ | REB-5 | 1.75 | 1.88 | .56 | .63 | .63 | 1.00 | 2.37 |
| | REB-10 | 2.50 | 2.63 | 1.00 | .88 | 1.00 | 1.38 | 3.07 |
| Plunger | REP-5 | 1.13 | 1.62 | .56 | .63 | .63 | .75 | — |
| | REP-10 | 1.69 | 2.43 | 1.00 | .88 | 1.00 | 1.13 | — |

* Pin to Pin- REB and REP Clevises fitted. Add cylinder stroke length.
¹⁾ Mounting screws are included.

Product selection

| Cylinder capacity at 5000 psi | Stroke | Model number | Effective area | Oil capacity | Operating pressure |
|-------------------------------|--------|--------------|----------------|--------------|--------------------|
| | | | | | |
| ▼ Block models | | | | | |
| 4970 | 0.62 | RW-41 | 0.99 | 0.62 | 85-8000 |
| 4970 | 0.62 | RW-50 | 0.99 | 0.62 | 600-10,000 |
| 4970 | 0.59 | MRW-50F | 0.99 | 0.62 | 85-10,000 |
| 4970 | 0.59 | MRW-50M | 0.99 | 0.62 | 85-10,000 |
| ▼ Cylindrical models | | | | | |
| 4970 | 1.01 | RW-51 | 0.99 | 0.99 | 600-10,000 |
| 4970 | 3.17 | RW-53 | 0.99 | 2.97 | 600-10,000 |
| 4970 | 5.17 | RW-55 | 0.99 | 4.95 | 600-10,000 |
| 11,180 | 0.99 | RW-101 | 2.23 | 2.23 | 600-10,000 |
| 11,180 | 2.18 | RW-102 | 2.23 | 4.75 | 600-10,000 |
| 11,180 | 4.18 | RW-104 | 2.23 | 9.21 | 600-10,000 |
| 11,180 | 6.11 | RW-106 | 2.23 | 13.67 | 600-10,000 |
| 11,180 | 10.13 | RW-1010 | 2.23 | 22.59 | 600-10,000 |

Note: Seal material Buna-N, Polyurethan.

RW-41

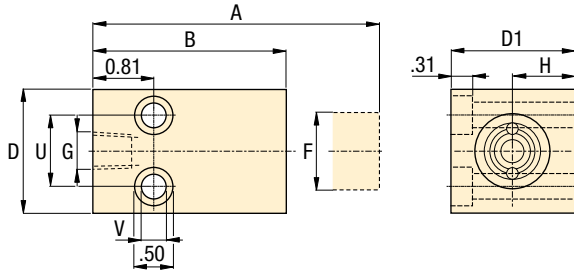

RW-50

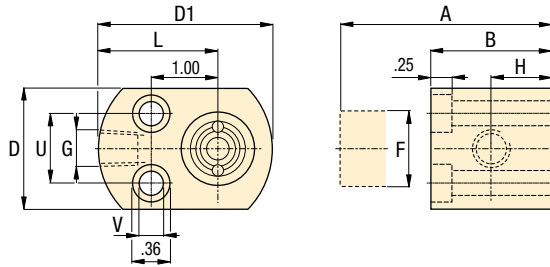

MRW-50F

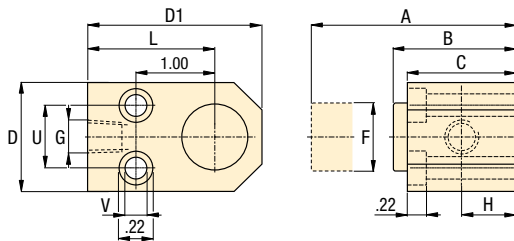

MRW-50M

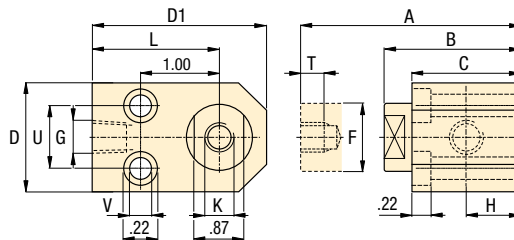

RW-series

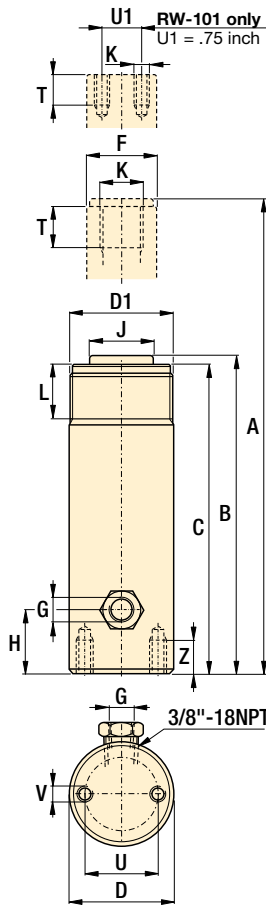

Force: 4970-11,180 lbs

Stroke: .59-10.13 inch

Pressure: 600-5000 psi

- E** Cilindros universales
- F** Vérins universels
- D** Universelle Linearzylinder



Options

Cylinder accessories

86 ▶



Important

These cylinders are intended for medium cycle applications. The return spring is intended for retracting the plunger and heavy devices should not be attached to it.

Plungers should be shielded in welding applications to prevent splatter from sticking to chrome plating.

Do not use these cylinders continuously at full stroke or damage to return spring may result.

Product dimensions in inches []

| Model number | A | B | C | D | D1 | F | G | H | J | K | L | T | U | V | Z | lbs |
|-----------------------------|-------|-------|-------|------|--------------|------|---------|------|------|-------------|------|------|------|-------------|------|------|
| ▼ Block models | | | | | | | | | | | | | | | | |
| RW-41 | 3.18 | 2.56 | - | 1.62 | 1.62 | 1.00 | .250-18 | 0.81 | - | - | - | - | 1.00 | 0.35 | - | 1.8 |
| RW-50 | 2.24 | 1.62 | - | 1.62 | 2.32 | 1.00 | .375-18 | 0.75 | - | - | 1.50 | - | 1.12 | 0.22 | - | 1.8 |
| MRW-50F | 2.20 | 1.61 | 1.61 | 1.62 | 2.56 | 1.00 | .375-18 | 0.81 | - | - | 1.75 | - | 1.12 | 0.22 | - | 1.8 |
| MRW-50M | 2.60 | 2.01 | 1.61 | 1.62 | 2.56 | 1.00 | .375-18 | 0.81 | - | M8x1,25 | 1.75 | 0.24 | 1.12 | 0.22 | - | 1.8 |
| ▼ Cylindrical models | | | | | | | | | | | | | | | | |
| RW-51 | 5.42 | 4.41 | 4.09 | 1.50 | 1.500-16 UN | 1.00 | .250-18 | 0.75 | 1 | .750-16 UNF | 1.18 | 0.61 | 1.00 | .250-20 UNC | 0.55 | 2.1 |
| RW-53 | 9.73 | 6.56 | 6.25 | 1.50 | 1.500-16 UN | 1.00 | .250-18 | 0.75 | 1 | .750-16 UNF | 1.18 | 0.61 | 1.00 | .250-20 UNC | 0.55 | 3.1 |
| RW-55 | 13.74 | 8.57 | 8.25 | 1.50 | 1.500-16 UN | 1.00 | .250-18 | 0.75 | 1 | .750-16 UNF | 1.18 | 0.61 | 1.00 | .250-20 UNC | 0.55 | 3.9 |
| RW-101 | 4.53 | 3.54 | 3.41 | 2.25 | 2.250-14 UNS | 1.50 | .250-18 | 0.75 | - | #10-24 UNC | 1.15 | 0.24 | 1.56 | .312-18 UNC | 0.49 | 3.8 |
| RW-102 | 6.97 | 4.79 | 4.53 | 2.25 | 2.250-14 UNS | 1.50 | .250-18 | 0.75 | 1.38 | 1.000-8 UNC | 1.15 | 0.68 | 1.56 | .312-18 UNC | 0.49 | 4.9 |
| RW-104 | 10.97 | 6.79 | 6.53 | 2.25 | 2.250-14 UNS | 1.50 | .250-18 | 0.75 | 1.38 | 1.000-8 UNC | 1.15 | 0.68 | 1.56 | .312-18 UNC | 0.49 | 7.0 |
| RW-106 | 15.82 | 9.71 | 9.5 | 2.25 | 2.250-14 UNS | 1.50 | .250-18 | 0.75 | 1.38 | 1.000-8 UNC | 1.15 | 0.68 | 1.56 | .312-18 UNC | 0.49 | 9.6 |
| RW-1010 | 23.88 | 13.75 | 13.50 | 2.25 | 2.250-14UN | 1.50 | .250-18 | 0.75 | 1.38 | 1.000-18UN | 1.13 | 0.75 | 1.56 | .312-18un | 0.50 | 13.8 |

Universal cylinders - Double acting *Application & selection*

Shown: RD-2510, RD-96, RD-256, RD-41, RD-166



Used when high cylinder forces with a powered return stroke is required in a confined area.

Cylinders can push or pull a workpiece into position and the threaded plunger allows adapting standard clevis attachments.

Clamping application using Enerpac RD cylinders (with clevis eye attachments on both ends) for their high pressure capability and mounting flexibility.

Collet-Lok® product line
Swing clamps
Work supports
Linear clamps

Heavy-duty cylinders

...provide push as well as pull forces

- High pressure design when additional force is required for push or pull applications
- Long strokes in a compact design are well suited for custom toggle style clamping
- Various features for mounting
- Threaded plunger allows a wide range of mounting adapter devices
- Chrome plated plunger provides a long cylinder life

Optional cylinder attachments

For added cylinder flexibility, a selection of interchangeable mountings is available to fit plunger or cylinder threads.



Foot mounting

Mounts onto cylinder collar thread. Retainer nut included. Mounting screws not included.



Flange mounting

Mounts onto cylinder collar thread. Retainer nut included. Mounting screws not included.



Retainer nut

Locking foot or flange mountings. Mounts onto cylinder base or collar threads. Included with foot and flange mountings.



Clevis eye

Threads onto plunger or base.

Product selection

| Cylinder capacity at 5000 psi | Stroke | | Model number | Effective area | | Oil capacity | |
|-------------------------------|----------|-------|--------------|-----------------|------|-----------------|-------|
| | in | | | in ² | | in ³ | |
| | push lbs | pull | | push | pull | push | pull |
| 3900 | 1720 | 1.11 | RD-41 | .79 | .34 | .89 | .40 |
| 3900 | 1720 | 3.11 | RD-43 | .79 | .34 | 2.47 | 1.10 |
| 3900 | 1720 | 6.11 | RD-46 | .79 | .34 | 4.84 | 2.10 |
| 9000 | 4910 | 1.15 | RD-91 | 1.77 | .98 | 2.00 | 1.10 |
| 9000 | 4910 | 3.15 | RD-93 | 1.77 | .98 | 5.54 | 3.00 |
| 9000 | 4910 | 6.15 | RD-96 | 1.77 | .98 | 10.88 | 6.00 |
| 9000 | 4910 | 10.15 | RD-910 | 1.77 | .98 | 17.94 | 9.90 |
| 15,500 | 8300 | 6.24 | RD-166 | 3.15 | 1.66 | 19.67 | 10.40 |
| 15,500 | 8300 | 10.24 | RD-1610 | 3.15 | 1.66 | 32.26 | 17.00 |
| 24,500 | 10,750 | 6.30 | RD-256 | 4.92 | 2.15 | 30.73 | 13.40 |
| 24,500 | 10,750 | 10.28 | RD-2510 | 4.92 | 2.15 | 50.40 | 22.00 |



98_049

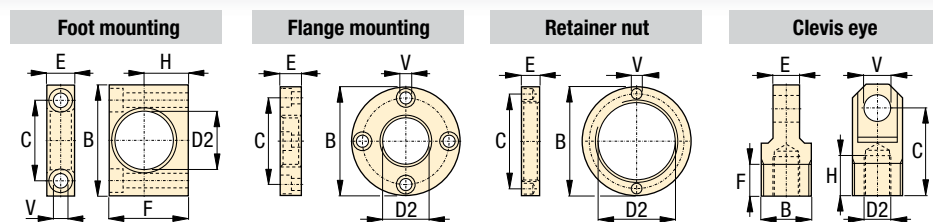

Cylinder attachments in inches []

| Cylinder capacity at | | D2 | Model number | B | C | E | F | H | V | lbs |
|--|------------|--------------|---------------|--------------|------|------|------|------|------|------|
| 5000 psi | 10,000 psi | | | | | | | | | |
| lbs | lbs | | | | | | | | | |
| ▼ Foot mounting with retainer nut | | | | | | | | | | |
| 3900 | 7800 | 1.38 | AD-141 | 3.00 | 2.00 | 0.75 | 2.25 | 1.25 | 0.41 | 0.9 |
| 9000 | 18,000 | 2.00 | AD-171 | 4.00 | 2.88 | 1.00 | 3.25 | 1.75 | 0.53 | 2.6 |
| 15,500 | 31,000 | 2.63 | AD-181 | 5.00 | 3.75 | 1.38 | 4.00 | 2.06 | 0.78 | 6.4 |
| 24,500 | 49,000 | 3.25 | AD-191 | 6.25 | 4.62 | 1.75 | 4.88 | 2.50 | 1.03 | 9.9 |
| ▼ Flange mounting with retainer nut | | | | | | | | | | |
| 3900 | 7800 | 1.38 | AD-142 | 3.88 | 3.09 | 0.75 | - | - | 0.41 | 2.2 |
| 9000 | 18,000 | 2.00 | AD-172 | 4.75 | 3.88 | 1.00 | - | - | 0.41 | 4.6 |
| 15,500 | 31,000 | 2.63 | AD-182 | 5.63 | 4.56 | 1.38 | - | - | 0.53 | 8.4 |
| 24,500 | 49,000 | 3.25 | AD-192 | 6.50 | 5.34 | 1.75 | - | - | 0.66 | 13.2 |
| ▼ Retainer nut | | | | | | | | | | |
| 3900 | 7800 | 1.375-12 UNF | AD-143 | 2.25 | 1.81 | 0.38 | - | - | 0.25 | 0.2 |
| 9000 | 18,000 | 2.000-12 UN | AD-173 | 3.00 | 2.50 | 0.50 | - | - | 0.27 | 0.7 |
| 15,500 | 31,000 | 2.625-16 UN | AD-183 | 3.63 | 3.13 | 0.75 | - | - | 0.27 | 1.3 |
| 24,500 | 49,000 | 3.250-16 UN | AD-193 | 4.25 | 3.75 | 1.00 | - | - | 0.27 | 1.8 |
| ▼ Clevis eye | | | | | | | | | | |
| 3900 | 7800 | .500-20 UNF | AD-150 | 1.125-20 UN | 2.06 | 0.62 | 0.75 | 0.94 | 0.63 | 0.5 |
| 9000 | 18,000 | .750-16 UNF | AD-151 | 1.688-18 UNF | 2.25 | 1.00 | 1.00 | 0.94 | 0.75 | 1.3 |
| 15,500 | 31,000 | 1.125-12 UNF | AD-152 | 2.187-16 UNS | 3.06 | 1.25 | 1.00 | 1.19 | 1.00 | 2.9 |
| 24,500 | 49,000 | 1.500-12 UNF | AD-153 | 2.750-16 UN | 3.06 | 1.50 | 1.00 | 1.06 | 1.25 | 4.6 |

Force: 3900-24,500 lbs

Stroke: 1.11-10.28 inch

Pressure: 500-10,000 psi

- E** Cilindros universales
- F** Vérins universels
- D** Universelle Linearzylinder



Options

Cylinder accessories

86 ▶

Important

Be certain that the mounting devices can handle the forces in the push and pull direction.

RD series cylinders are designed for a maximum operating pressure of 10,000 psi.

When applying 10,000 psi cylinder capacities double as well.

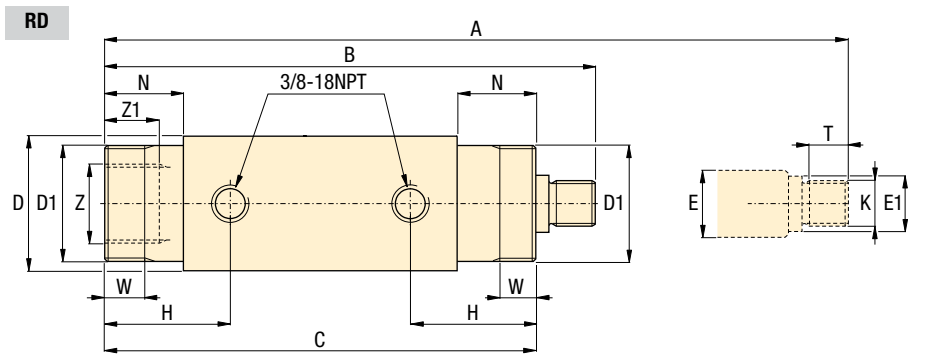

Product dimensions in inches []

| Model number | A | B | C | D | D1 | E | E1 | H | K | N | T | W | Z | Z1 | lbs |
|----------------|-------|-------|-------|------|----------|------|------|------|----------|------|------|------|----------|------|------|
| | | | | | UN | | | | UN | | | | UN | | |
| RD-41 | 8.41 | 7.30 | 6.39 | 2.00 | 1.375-12 | 0.75 | 0.69 | 1.85 | .500-20 | 1.14 | 0.76 | 0.43 | 1.125-20 | 0.47 | 4.8 |
| RD-43 | 12.41 | 9.30 | 8.39 | 2.00 | 1.375-12 | 0.75 | 0.69 | 1.85 | .500-20 | 1.14 | 0.76 | 0.43 | 1.125-20 | 0.47 | 6.4 |
| RD-46 | 18.41 | 12.30 | 11.39 | 2.00 | 1.375-12 | 0.75 | 0.69 | 1.85 | .500-20 | 1.14 | 0.76 | 0.43 | 1.125-20 | 0.47 | 9.0 |
| RD-91 | 9.93 | 8.78 | 7.81 | 2.50 | 2.000-12 | 1.00 | 0.94 | 2.27 | .750-16 | 1.50 | 0.77 | 0.56 | 1.688-18 | 0.63 | 9.0 |
| RD-93 | 13.93 | 10.78 | 9.81 | 2.50 | 2.000-12 | 1.00 | 0.94 | 2.27 | .750-16 | 1.50 | 0.77 | 0.56 | 1.688-18 | 0.63 | 11.0 |
| RD-96 | 19.93 | 13.78 | 9.81 | 2.50 | 2.000-12 | 1.00 | 0.94 | 2.27 | .750-16 | 1.50 | 0.77 | 0.56 | 1.688-18 | 0.63 | 14.0 |
| RD-910 | 27.93 | 17.78 | 16.81 | 2.50 | 2.000-12 | 1.00 | 0.94 | 2.27 | .750-16 | 1.50 | 0.77 | 0.56 | 1.688-18 | 0.63 | 19.0 |
| RD-166 | 21.57 | 15.33 | 14.13 | 3.00 | 2.625-16 | 1.37 | 1.26 | 2.90 | 1.125-12 | 2.12 | 1.00 | 0.88 | 2.187-16 | 1.00 | 22.0 |
| RD-1610 | 29.57 | 19.33 | 18.13 | 3.00 | 2.625-16 | 1.37 | 1.26 | 2.90 | 1.125-12 | 2.12 | 1.00 | 0.88 | 2.187-16 | 1.00 | 29.0 |
| RD-256 | 22.98 | 16.68 | 15.63 | 3.54 | 3.250-16 | 1.87 | 1.77 | 3.50 | 1.500-12 | 2.76 | 0.90 | 1.12 | 2.750-16 | 0.99 | 36.0 |
| RD-2510 | 30.95 | 20.67 | 19.61 | 3.54 | 3.250-16 | 1.87 | 1.77 | 3.50 | 1.500-12 | 2.76 | 0.90 | 1.12 | 2.750-16 | 0.99 | 46.0 |

Linear cylinders
Power sources
Valves
Pallet components
System components
Yellow pages

Cylinder accessories

Shown: Cylinder accessories



These accessories are provided so that you can effectively position, mount and actuate Enerpac hydraulic cylinders according to your specific fixturing or production applications.

Enerpac worksupport locked in position using an FN series self-locking flange nut.



For optimum mounting and fixture flexibility

...to match specific applications

- **Contact bolts**
Allow cylinders to act as a datum point in your clamping applications, and protect the piston when cylinders are used for pushing applications
- **Cylindrical flange nuts**
For mounting threaded body cylinders in any position
- **Mounting brackets**
For bolting cylinders to suit the application

All BS Models

FN-121, 201, 251

FN-48, 55, 65, 80

All Other FN Models

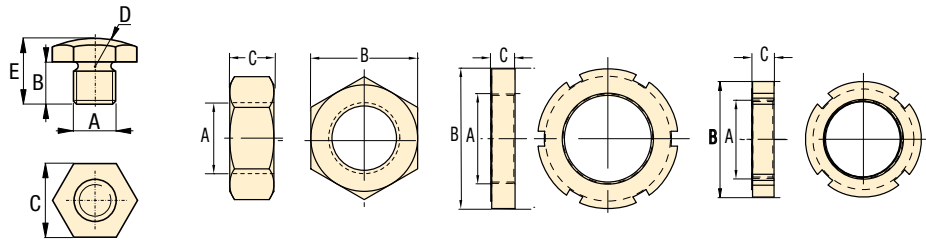

Product dimensions in inches []

| A | Model number | B | C | D | E | A | Model number | B | C |
|----------------------------------|---------------|------|-----|-----|-----|--------------|---------------|------|------|
| thread | | rad. | | | | thread | | | |
| ▼ Spherical contact bolts | | | | | | | | | |
| #6-32 UNC | BS-21 | .20 | .25 | .24 | .35 | 0.500-20 UNF | FN-121 | 0.75 | 0.31 |
| #8-32 UNC | BS-41 | .28 | .31 | .31 | .43 | M12 x 1,5 | FN-122 | 1.10 | 0.24 |
| M4 x 0,7 | BS-42 | .28 | .31 | .31 | .43 | 0.750-16 UNF | FN-201 | 1.13 | 0.42 |
| .250-28 UNF | BS-61 | .31 | .44 | .44 | .55 | M20 x 1,5 | FN-202 | 1.12 | 0.31 |
| M6 x 1,0 | BS-62 | .31 | .44 | .44 | .55 | 1.000-12 UNF | FN-251 | 1.50 | 0.55 |
| .313-24 UNF | BS-81 | .39 | .56 | .55 | .67 | 1.125-16 UN | FN-281 | 1.75 | 0.39 |
| M8 x 1,25 | BS-82 | .39 | .55 | .55 | .67 | M28 x 1,5 | FN-282 | 1.97 | 0.39 |
| .375-16 UNC | BS-91 | .39 | .63 | .63 | .67 | 1.250-16 UN | FN-301 | 1.88 | 0.39 |
| .500-13 UNC | BS-101 | .39 | .69 | .67 | .71 | M30 x 1,5 | FN-302 | 1.97 | 0.39 |
| M10 x 1,5 | BS-102 | .26 | .67 | .91 | .43 | 1.313-16 UN | FN-331 | 1.88 | 0.25 |
| M16 x 2,0 | BS-162 | .47 | .87 | .87 | .94 | 1.375-18 UNF | FN-351 | 1.88 | 0.25 |
| M20 x 2,5 | BS-202 | .47 | .94 | .87 | .94 | M35 x 1,5 | FN-352 | 2.17 | 0.43 |
| ▼ Jam nuts | | | | | | | | | |
| | | | | | | 1.625-16 UN | FN-421 | 2.25 | 0.31 |
| | | | | | | M42 x 1,5 | FN-422 | 2.44 | 0.47 |
| | | | | | | 1.875-16 UN | FN-481 | 2.50 | 0.51 |
| | | | | | | M48 x 1,5 | FN-482 | 2.95 | 0.51 |
| | | | | | | 2.125-16 UN | FN-551 | 3.13 | 0.38 |
| | | | | | | M55 x 1,5 | FN-552 | 3.15 | 0.51 |
| | | | | | | 2.500-16 UN | FN-651 | 3.25 | 0.39 |
| | | | | | | M65 x 1,5 | FN-652 | 3.74 | 0.55 |
| | | | | | | 3.125-16 UN | FN-801 | 4.13 | 0.51 |
| | | | | | | M80 x 2,0 | FN-802 | 4.53 | 0.63 |

Product dimensions in inches []

| A | Model number | B | C | D | E | F | H | J |
|---------------|---------------|-----|-----|-----|------|-----|-----|------|
| thread | | ø | | | | | | |
| ▼ Yoke | | | | | | | | |
| .313-24 UNF | Y-3121 | .50 | .31 | .31 | 1.25 | .63 | .50 | 1.56 |

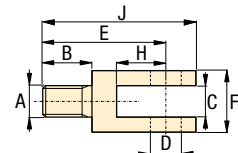

MF and AW-51 models

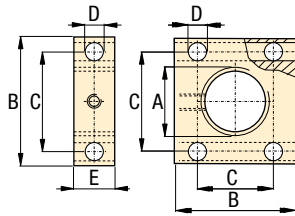

other AW models

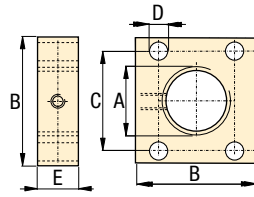

- E** Accesorios de cilindro
- F** Accessoires pour vérins
- D** Zubehör für Zylinder

Product dimensions in inches []

| A thread | Model number | B | C | D ø | E |
|-------------|-----------------|---|---|--------|---|
|-------------|-----------------|---|---|--------|---|

▼ Mounting flanges – Rectangular

| | | | | | |
|---------------|---------------|-----------|-----------|------|------|
| 1.375-18 UNEF | AW-5 | 1.75 | 1.34 | 0.27 | 0.50 |
| 1.500-16 UN | AW-51 | 2.25-2.75 | 1.62-2.12 | 0.41 | 1.00 |
| 1.875-16 UN | AW-89 | 2.25 | 1.77 | 0.33 | 1.00 |
| 2.500-16 UN | AW-19 | 3.25 | 2.17 | 0.35 | 0.98 |
| 3.125-16 UN | AW-90 | 3.75x4.75 | 2.38x3.50 | 0.64 | 1.25 |
| 0.500-20 UNF | MF-121 | 1.50 | 1.00 | 0.27 | 1.00 |
| M12 x 1,5 | MF-122 | 1.57 | 0.98 | 0.25 | 0.98 |
| 0.750-16 UNF | MF-201 | 2.25 | 1.50 | 0.40 | 1.50 |
| M20 x 1,5 | MF-202 | 2.56 | 1.77 | 0.40 | 1.57 |
| 1.000-12 UNF | MF-251 | 2.50 | 1.75 | 0.40 | 1.50 |
| 1.125-16 UN | MF-281 | 2.75 | 2.00 | 0.40 | 1.50 |
| M28 x 1,5 | MF-282 | 2.95 | 1.97 | 0.40 | 1.57 |
| 1.313-16 UN | MF-331 | 3.00 | 2.25 | 0.40 | 1.50 |
| 1.375-18 UNEF | MF-351 | 3.00 | 2.25 | 0.40 | 1.50 |
| M35 x 1,5 | MF-352 | 3.15 | 2.24 | 0.40 | 1.57 |
| 1.625-16 UN | MF-421 | 3.25 | 2.50 | 0.40 | 1.50 |
| M42 x 1,5 | MF-422 | 3.54 | 2.48 | 0.40 | 1.57 |
| 1.875-16 UN | MF-481 | 3.50 | 2.75 | 0.40 | 1.50 |
| M48 x 1,5 | MF-482 | 3.74 | 2.76 | 0.40 | 1.57 |
| 2.125-16 UN | MF-551 | 4.00 | 3.00 | 0.46 | 1.75 |
| M55 x 1,5 | MF-552 | 4.33 | 3.23 | 0.47 | 1.77 |
| 2.500-16 UN | MF-651 | 4.50 | 3.50 | 0.46 | 1.75 |
| M65 x 1,5 | MF-652 | 4.53 | 3.50 | 0.47 | 1.77 |
| 3.125-16 UN | MF-801 | 5.00 | 4.00 | 0.46 | 1.75 |
| M80 x 2,0 | MF-802 | 5.31 | 4.25 | 0.47 | 1.77 |

AW-53, -121

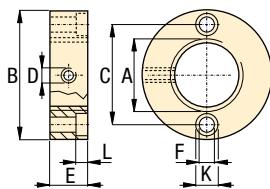

AW-102

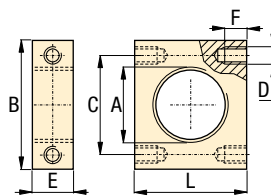

Product dimensions in inches []

| A thread | Model number | B ø | C | D thread | E ø | F ø | K ø | L |
|-------------|-----------------|--------|---|-------------|--------|--------|--------|---|
|-------------|-----------------|--------|---|-------------|--------|--------|--------|---|

▼ Mounting flanges – Cylindrical

| | | | | | | | | |
|-------------|---------------|------|------|-------------|-----|-----|-----|------|
| 1.500-16 UN | AW-53 | 2.88 | 2.25 | .250-20 UNC | .75 | .28 | .41 | 0.31 |
| 2.750-16 UN | AW-121 | 4.50 | 3.63 | .250-20 UNC | .75 | .34 | .50 | .38 |

▼ Mounting flanges – Rectangular

| | | | | | | | | |
|--------------|---------------|------|------|-------------|------|-----|---|------|
| 2.250-14 UNS | AW-102 | 4.00 | 3.00 | .438-20 UNF | 1.25 | .62 | – | 3.25 |
|--------------|---------------|------|------|-------------|------|-----|---|------|

5000 psi Tie Rod Cylinders

Shown: TRFM-1506, TRFL-3210 and TRCM-3206



Enerpac 5000 psi Tie Rod cylinders provide a variety of mounting options for pushing and positioning workpieces and fixtures on a machine. Enerpac tie rod cylinders are designed to the highest industry standards to provide long life and worry-free performance in the most demanding applications.

Performance tested design features at 5000 psi

- Rod seal (1) uses spring loaded multiple lip vee rings, a supporting bronze bearing ring bushing and a double lip wiper
- Piston seal (2) combines two bi-directional sealing cast iron piston rings with two block vee seals with back-up rings
- Hardened chrome plated piston rod (3) resists scoring and corrosion, assuring maximum life
- Steel tubing barrel (4), honed to a fine finish assures superior sealing, minimum friction and maximum seal life
- Rod bushing and seals can be serviced by merely removing the retainer plate (5) on most models

Tie Rod cylinder construction

- 1 Rod Seal
- 2 Piston Seal
- 3 Piston Rod
- 4 Barrel
- 5 Retainer Plate

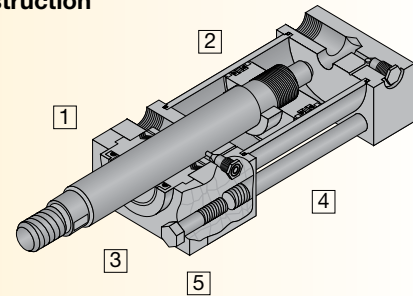

Tie Rod cylinder mounting styles

Clevis Mount – TRCM Series

- NFPA style MP1
- Allows cylinder to pivot
- Requires provision for pivoting on rod end

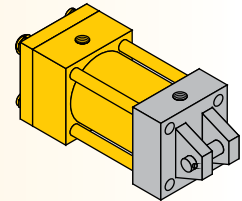

Foot mount – TRFM series

- NFPA style MS2
- Allows easy mounting with only four bolts
- Backup key included in design to ensure long life

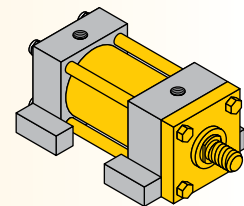

Flange mount – TRFL series

- NFPA style ME5
- Allows cylinder length to be buried in machine
- Strongest, most rigid mount

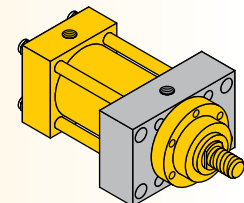

Standard bore sizes

| Bore diameter in | Rod diameter in | Capacity at 5000 psi | | Effective area | |
|---------------------|--------------------|----------------------|----------|----------------------|----------------------|
| | | Push lbs | Pull lbs | Push in ² | Pull in ² |
| 1.50 | 1.00 | 8,850 | 4,900 | 1.77 | 0.98 |
| 2.00 | 1.38 | 15,700 | 8,300 | 3.14 | 1.66 |
| 2.50 | 1.75 | 24,550 | 12,500 | 4.91 | 2.50 |
| 3.25 | 2.00 | 41,500 | 25,800 | 8.30 | 5.16 |
| 4.00 | 2.50 | 62,850 | 38,300 | 12.57 | 7.66 |

Additional bore sizes

| Bore diameter in | Rod diameter in | Capacity at 5000 psi | |
|---------------------|--------------------|----------------------|----------|
| | | Push lbs | Pull lbs |
| 5.00 | 3.50 | 98,170 | 50,060 |
| 6.00 | 4.00 | 141,400 | 78,550 |
| 7.00 | 5.00 | 192,400 | 94,220 |
| 8.00 | 5.50 | 251,400 | 132,600 |

Contact Enerpac for ordering information on additional bore sizes.

Product selection

| Piston diameter | Rod diameter | Stroke | Clevis mount | Foot mount | Flange mount |
|-----------------|--------------|--------|--------------|------------|--------------|
| in | in | in | | | |
| 1.50 | 1.00 | 2 | TRCM-1502 | TRFM-1502 | TRFL-1502 |
| 1.50 | 1.00 | 4 | TRCM-1504 | TRFM-1504 | TRFL-1504 |
| 1.50 | 1.00 | 6 | TRCM-1506 | TRFM-1506 | TRFL-1506 |
| 1.50 | 1.00 | 10 | TRCM-1510* | TRFM-1510 | TRFL-1510 |
| 1.50 | 1.00 | 12 | TRCM-1512* | TRFM-1512 | TRFL-1512 |
| 2.00 | 1.38 | 2 | TRCM-2002 | TRFM-2002 | TRFL-2002 |
| 2.00 | 1.38 | 4 | TRCM-2004 | TRFM-2004 | TRFL-2004 |
| 2.00 | 1.38 | 6 | TRCM-2006 | TRFM-2006 | TRFL-2006 |
| 2.00 | 1.38 | 10 | TRCM-2010 | TRFM-2010 | TRFL-2010 |
| 2.00 | 1.38 | 12 | TRCM-2012 | TRFM-2012 | TRFL-2012 |
| 2.50 | 1.75 | 2 | TRCM-2502 | TRFM-2502 | TRFL-2502 |
| 2.50 | 1.75 | 4 | TRCM-2504 | TRFM-2504 | TRFL-2504 |
| 2.50 | 1.75 | 6 | TRCM-2506 | TRFM-2506 | TRFL-2506 |
| 2.50 | 1.75 | 10 | TRCM-2510 | TRFM-2510 | TRFL-2510 |
| 2.50 | 1.75 | 12 | TRCM-2512 | TRFM-2512 | TRFL-2512 |
| 3.25 | 2.00 | 2 | TRCM-3202 | TRFM-3202 | TRFL-3202 |
| 3.25 | 2.00 | 4 | TRCM-3204 | TRFM-3204 | TRFL-3204 |
| 3.25 | 2.00 | 6 | TRCM-3206 | TRFM-3206 | TRFL-3206 |
| 3.25 | 2.00 | 10 | TRCM-3210 | TRFM-3210 | TRFL-3210 |
| 3.25 | 2.00 | 12 | TRCM-3212 | TRFM-3212 | TRFL-3212 |
| 4.00 | 2.50 | 2 | TRCM-4002 | TRFM-4002 | TRFL-4002 |
| 4.00 | 2.50 | 4 | TRCM-4004 | TRFM-4004 | TRFL-4004 |
| 4.00 | 2.50 | 6 | TRCM-4006 | TRFM-4006 | TRFL-4006 |
| 4.00 | 2.50 | 10 | TRCM-4010 | TRFM-4010 | TRFL-4010 |
| 4.00 | 2.50 | 12 | TRCM-4012 | TRFM-4012 | TRFL-4012 |

Cushions are available for all cylinder models. Cushions slow down heavy loads prior to end of stroke, preventing damage to the cylinder of the machine. To add cushions to your Enerpac Tie Rod cylinder, simply add the letter "C" to the end of any model number. Note: the addition of cushions does not affect the outside dimensions of the cylinder.

* These models are only rated to 4000 psi due to constraints on the mechanical properties of the rod.

Custom build your Tie Rod cylinder

| TR | CM | 15 | 12 | C |
|---------------------------------------|----|--|--|---|
| 1 | 2 | 3 | 4 | 5 |
| 1 Product Type TR = Tie Rod | | 3 Bore Diameter 15 = 1.5" 20 = 2.0" 25 = 2.5" 32 = 3.25" 40 = 4.0" | 4 Stroke 02 = 2" 04 = 4" 06 = 6" 10 = 10" 12 = 12" | 5 Cushions Blank = None C = Cushions both ends |

Seal and repair kits

Seal kits include piston, rod and barrel seals. Repair kits include seal kit plus rod bushing and rear bearing ring.

Product dimensions in inches

| Bore diameter in | Rod diameter in | Seal kit | Repair kit |
|------------------|-----------------|----------|------------|
| 1.50 | 1.00 | TR15SK | TR15RK |
| 2.00 | 1.38 | TR20SK | TR20RK |
| 2.50 | 1.75 | TR25SK | TR25RK |
| 3.25 | 2.00 | TR32SK | TR32RK |
| 4.00 | 2.50 | TR40SK | TR40RK |

Force: 8850-62,850 lbs.

Stroke: 2-12 inches

Pressure: 500-5000 psi

- E** Cilindros Atirantados
- F** Vérins à tirants
- D** Zugankerzylinder

Options

Accessories  93 ▶

ZW Series Pumps  114 ▶

VP Series Valves  136 ▶

Fittings  194 ▶

Important

Consult individual product selection pages for application and installation criteria specific to each mounting style. If you are unsure of an application, contact Enerpac directly.

Enerpac can provide many other tie rod cylinders in a wide variety of mounting styles, bore and stroke sizes. Contact Enerpac directly and talk to our Custom Products group for a quotation.

Shown: TRCM-3204



TR series clevis mount

Enerpac clevis mount 5000 psi Tie Rod cylinders provide for motion in two axis, increasing the range of motion on your machine with only one cylinder.

Special rod ends

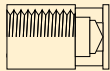

- Either internal or external threads available
- Custom designs to match your tooling requirements

Flexibility of motion

- Clevis mount cylinders include pivot pin for mounting in your machine
- Standard rod eyes and rod clevises available for each bore size.
- NFPA style MP1
- Designed to carry shear loads
- Pivot pins should be carried by rigidly held bearings and closely fit for the entire length of the pin

TRCM models Clevis mount

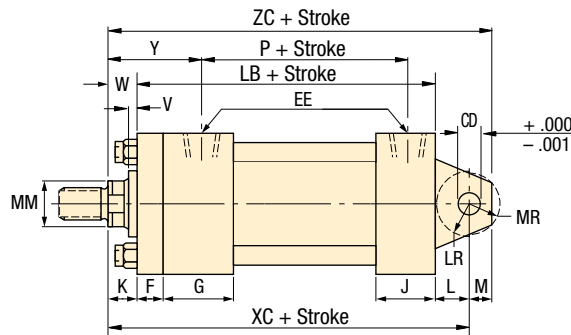
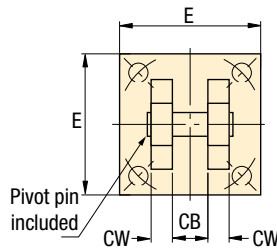

Force: 8850-62,850 lbs.

Stroke: 2-12 inches

Pressure: 500-5000 psi

E Cilindros Atirantados

F Vérins à tirants

D Zugankerzylinder

Options

Accessories

93 ▶



ZW Series Pumps

114 ▶



VP Series Valves

136 ▶



Fittings

194 ▶



Dimensions in inches []

| Bore diameter | Rod diameter | Model number | A | B | C | CB | CD | CW | D* | E | EE | F | G | J | K |
|---------------|--------------|--------------|------|------|------|------|------|------|------|------|---------|------|------|------|------|
| 1.50 | 1.00 | TRCM-15xx** | 1.13 | 1.50 | 0.50 | 0.75 | 0.50 | 0.50 | 0.88 | 2.50 | SAE #10 | 0.38 | 1.75 | 1.50 | 0.50 |
| 2.00 | 1.38 | TRCM-20xx | 1.63 | 2.00 | 0.63 | 1.25 | 0.75 | 0.63 | 1.13 | 3.00 | SAE #10 | 0.63 | 1.75 | 1.50 | 0.63 |
| 2.50 | 1.75 | TRCM-25xx | 2.00 | 2.38 | 0.75 | 1.25 | 0.75 | 0.63 | 1.50 | 3.50 | SAE #10 | 0.63 | 1.75 | 1.50 | 0.63 |
| 3.25 | 2.00 | TRCM-32xx | 2.25 | 2.63 | 0.88 | 1.50 | 1.00 | 0.75 | 1.69 | 4.50 | SAE #12 | 0.75 | 2.00 | 1.75 | 0.75 |
| 4.00 | 2.50 | TRCM-40xx | 3.00 | 3.13 | 1.00 | 2.00 | 1.38 | 1.00 | 2.06 | 5.00 | SAE #12 | 0.88 | 2.00 | 1.75 | 0.75 |

* D = Distance across plunger wrench flats.

** 10 and 12 inch models are rated at only 4000 psi.

| Bore diameter | Rod diameter | Model number | KK2 | L | LB | LR | M | MM | MR | NA | P | V | W | XC | Y | ZC | lbs |
|---------------|--------------|--------------|-----------|------|------|------|------|------|------|------|------|------|------|-------|------|-------|-----|
| 1.50 | 1.00 | TRCM-15xx | 3/4"-16 | 0.75 | 5.00 | 0.63 | 0.50 | 1.00 | 0.66 | 0.97 | 2.13 | 0.50 | 1.00 | 6.75 | 2.38 | 7.25 | *** |
| 2.00 | 1.38 | TRCM-20xx | 1"-14 | 1.25 | 5.25 | 1.13 | 0.75 | 1.38 | 0.94 | 1.34 | 2.88 | 0.38 | 1.00 | 7.50 | 2.63 | 8.25 | *** |
| 2.50 | 1.75 | TRCM-25xx | 1-1/4"-12 | 1.25 | 5.38 | 1.13 | 0.75 | 1.75 | 0.94 | 1.70 | 3.00 | 0.50 | 1.25 | 7.88 | 2.88 | 8.63 | *** |
| 3.25 | 2.00 | TRCM-32xx | 1-1/2"-12 | 1.50 | 6.25 | 1.25 | 1.00 | 2.00 | 1.19 | 1.95 | 3.59 | 0.38 | 1.25 | 9.00 | 3.09 | 10.00 | *** |
| 4.00 | 2.50 | TRCM-40xx | 1-7/8"-12 | 2.13 | 6.63 | 1.88 | 1.38 | 2.50 | 1.38 | 2.45 | 3.88 | 0.38 | 1.38 | 10.13 | 3.31 | 11.50 | *** |

*** For product weights, please reference the price list or contact Enerpac customer service for more information.

Collet-Lok® product line
Swing clamps
Work supports
Linear clamps

Force: 8850-62,850 lbs.

Stroke: 2-12 inches

Pressure: 500-5000 psi

E Cilindros Atirantados

F Vérins à tirants

D Zugankerzylinder

Options

Accessories

93 ▶



ZW Series Pumps

114 ▶



VP Series Valves

136 ▶



Fittings

194 ▶

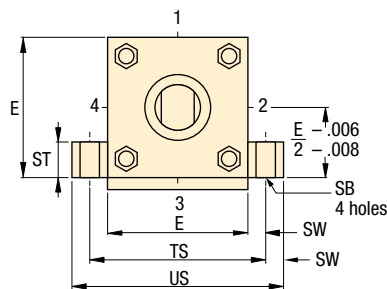

Ease of installation

- Foot mount cylinders provide simplest mounting option with just four bolt holes required
- Standard key mount is included ensuring proper mounting and adding rigidity
- NFPA style MS2
- Compact mounting fits in tight spaces where other cylinders cannot

TRFM models Foot Mount

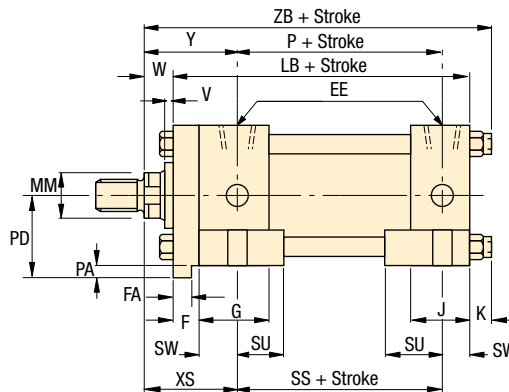
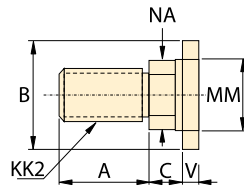

Dimensions in inches []

| Bore diameter | Rod diameter | Model number | A | B | C | D* | E | EE | F | FA | G | J | K | KK2 | LB | MM |
|---------------|--------------|--------------|------|------|------|------|------|---------|------|-------------|------|------|------|-----------|------|------|
| 1.50 | 1.00 | TRFM-15xx | 1.13 | 1.50 | 0.50 | 0.88 | 2.50 | SAE #10 | 0.38 | 0.310-0.312 | 1.75 | 1.50 | 0.50 | 3/4"-16 | 5.00 | 1.00 |
| 2.00 | 1.38 | TRFM-20xx | 1.63 | 2.00 | 0.63 | 1.13 | 3.00 | SAE #10 | 0.63 | 0.560-0.562 | 1.75 | 1.50 | 0.63 | 1"-14 | 5.25 | 1.38 |
| 2.50 | 1.75 | TRFM-25xx | 2.00 | 2.38 | 0.75 | 1.50 | 3.50 | SAE #10 | 0.63 | 0.560-0.562 | 1.75 | 1.50 | 0.63 | 1-1/4"-12 | 5.38 | 1.75 |
| 3.25 | 2.00 | TRFM-32xx | 2.25 | 2.63 | 0.88 | 1.69 | 4.50 | SAE #12 | 0.75 | 0.684-0.687 | 2.00 | 1.75 | 0.75 | 1-1/2"-12 | 6.25 | 2.00 |
| 4.00 | 2.50 | TRFM-40xx | 3.00 | 3.13 | 1.00 | 2.06 | 5.00 | SAE #12 | 0.88 | 0.809-0.812 | 2.00 | 1.75 | 0.75 | 1-7/8"-12 | 6.63 | 2.50 |

* D = Distance across plunger wrench flats.

| Bore diameter | Rod diameter | Model number | NA | P | PA | PD | SB | SS | ST | SU | SW | TS | US | V | W | XS | Y | ZB | |
|---------------|--------------|--------------|------|------|------|------|------|------|------|------|------|------|------|------|------|------|------|------|-----|
| 1.50 | 1.00 | TRFM-15xx | 0.97 | 2.88 | 0.19 | 1.44 | 0.44 | 3.88 | 0.50 | 0.94 | 0.38 | 3.25 | 4.00 | 0.50 | 1.00 | 1.75 | 2.38 | 6.50 | *** |
| 2.00 | 1.38 | TRFM-20xx | 1.34 | 2.88 | 0.31 | 1.81 | 0.56 | 3.63 | 0.75 | 1.25 | 0.50 | 4.00 | 5.00 | 0.38 | 1.00 | 2.13 | 2.63 | 6.88 | *** |
| 2.50 | 1.75 | TRFM-25xx | 1.70 | 3.00 | 0.31 | 2.06 | 0.81 | 3.38 | 1.00 | 1.56 | 0.69 | 4.88 | 6.25 | 0.50 | 1.25 | 2.56 | 2.88 | 7.25 | *** |
| 3.25 | 2.00 | TRFM-32xx | 1.95 | 3.59 | 0.38 | 2.63 | 0.81 | 4.13 | 1.00 | 1.56 | 0.69 | 5.88 | 7.25 | 0.38 | 1.25 | 2.69 | 3.09 | 8.25 | *** |
| 4.00 | 2.50 | TRFM-40xx | 2.45 | 3.88 | 0.44 | 2.94 | 1.06 | 4.00 | 1.25 | 2.00 | 0.88 | 6.75 | 8.50 | 0.38 | 1.38 | 3.13 | 3.31 | 8.75 | *** |

*** For product weights, please reference the price list or contact Enerpac customer service for more information.

Shown: TRFM-1506



TR series foot mount

Enerpac foot mount 5000 psi Tie Rod cylinders provide a high quality positioning solution using a minimal amount of space.

Important

Some custom options may require reduction of working pressure or special installation considerations. Contact Enerpac Technical Service to discuss your application.

Special rod ends

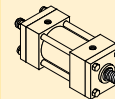

Double rod ends

- Available on all models except clevis mounts
- The two rod ends can be different on the same cylinder

98-037

Linear cylinders

Power sources

Valves

Pallet components

System components

Yellow pages

Shown: TRFL-3206



TR series flange mount
Enerpac flange mount 5000 psi Tie Rod cylinders provide the most rigid mounting ensuring long life and high accuracy on your machine.

Extra strong

- Flange mount is part of the cylinder end cap, providing maximum strength and rigidity
- Allows length of cylinder to be mounted inside the machine
- NFPA style ME5
- Simple four bolt mounting pattern makes installation easy
- Mounting is best suited for tensioning applications

Force: 8850-62,850 lbs.

Stroke: 2-12 inches

Pressure: 500-5000 psi

E Cilindros Atirantados

F VÉRINS à tirants

D Zugankerzylinder

Options

Accessories

86 ▶



ZW Series Pumps

114 ▶



VP Series Valves

136 ▶



Fittings

194 ▶



TRFL models Flange Mount

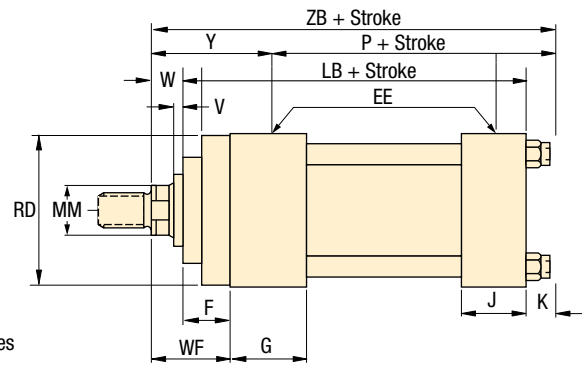
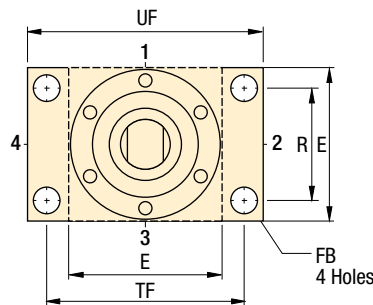
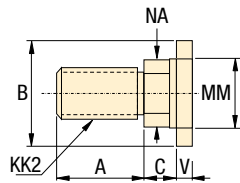

Special rod ends

Rod boots

- Rod boots are made from neoprene coated fabric
- Impervious to oil grease and water
- Rated for temperatures from 0° F to 200° F

Metallic wipers

- Recommended in applications where contaminants tend to cling to the rod surface
- Available on all rod diameters

Dimensions in inches [± 0.005]

| Bore diameter | Rod diameter | Model number | A | B | C | D* | E | EE | F | FB | G | J | K | KK2 |
|---------------|--------------|--------------|------|------|------|------|------|---------|------|------|------|------|------|-----------|
| 1.50 | 1.00 | TRFL-15xx | 1.13 | 1.50 | 0.50 | 0.88 | 2.50 | SAE #10 | 0.38 | 0.44 | 1.75 | 1.50 | 0.50 | 3/4"-16 |
| 2.00 | 1.38 | TRFL-20xx | 1.63 | 2.00 | 0.63 | 1.13 | 3.00 | SAE #10 | 0.63 | 0.56 | 1.75 | 1.50 | 0.63 | 1"-14 |
| 2.50 | 1.75 | TRFL-25xx | 2.00 | 2.38 | 0.75 | 1.50 | 3.50 | SAE #10 | 0.63 | 0.56 | 1.75 | 1.50 | 0.63 | 1-1/4"-12 |
| 3.25 | 2.00 | TRFL-32xx | 2.25 | 2.63 | 0.88 | 1.69 | 4.50 | SAE #12 | 0.75 | 0.69 | 2.00 | 1.75 | 0.75 | 1-1/2"-12 |
| 4.00 | 2.50 | TRFL-40xx | 3.00 | 3.13 | 1.00 | 2.06 | 5.00 | SAE #12 | 0.88 | 0.69 | 2.00 | 1.75 | 0.75 | 1-7/8"-12 |

* D = Distance across plunger wrench flats.

| Bore diameter | Rod diameter | Model number | LB | MM | NA | P | R | RD | TF | UF | V | W | WF | Y | ZB | lbs |
|---------------|--------------|--------------|------|------|------|------|------|------|------|------|------|------|------|------|------|-----|
| 1.50 | 1.00 | TRFL-15xx | 5.00 | 1.00 | 0.97 | 2.88 | 1.63 | - | 3.44 | 4.25 | 0.50 | 1.00 | 1.38 | 2.38 | 6.50 | *** |
| 2.00 | 1.38 | TRFL-20xx | 5.25 | 1.38 | 1.34 | 2.88 | 2.05 | - | 4.13 | 5.13 | 0.38 | 1.00 | 1.63 | 2.63 | 6.88 | *** |
| 2.50 | 1.75 | TRFL-25xx | 5.38 | 1.75 | 1.70 | 3.00 | 2.55 | - | 4.63 | 5.63 | 0.50 | 1.25 | 1.88 | 2.88 | 7.25 | *** |
| 3.25 | 2.00 | TRFL-32xx | 6.25 | 2.00 | 1.95 | 3.59 | 3.25 | 4.00 | 5.88 | 7.13 | 0.38 | 1.25 | 2.00 | 3.09 | 8.25 | *** |
| 4.00 | 2.50 | TRFL-40xx | 6.63 | 2.50 | 2.45 | 3.88 | 3.82 | 4.50 | 6.38 | 7.63 | 0.38 | 1.38 | 2.25 | 3.31 | 8.75 | *** |

*** For product weights, please reference the price list or contact Enerpac customer service for more information.

For high production applications

- Fit any style of Enerpac tie-rod cylinder
- Rod eyes and rod clevises
 - Required for proper mounting of TRCM series cylinders
 - Pivot pins supplied separately
- Pivot pins for rod eyes and clevises
 - Provided with cotter pins
 - Must be ordered separately
- Linear alignment coupler
 - Prevents binding caused by misalignment
 - Reduces rod seal and bearing wear

Shown: RRE-15, TRCC-15, TRPP-15, TRAC-15



Fittings dimensions in inches []

| From | To | Model number | A | B | C | D |
|---------|----------|---------------|------|------|---------|----------|
| SAE #10 | 3/8" NPT | FZ2077 | 1.31 | 1.00 | SAE #10 | 3/8" NPT |
| SAE #12 | 3/8" NPT | FZ2078 | 1.00 | 1.25 | SAE #12 | 3/8" NPT |
| SAE #10 | SAE #6 | FZ2079 | 1.26 | 1.00 | SAE #10 | SAE #6 |
| SAE #12 | SAE #6 | FZ2080 | 1.00 | 1.25 | SAE #12 | SAE #6 |

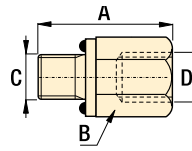

Enerpac 5000 psi Tie-Rod cylinder accessories allow you to complete your design making installation on your machine a simple project.

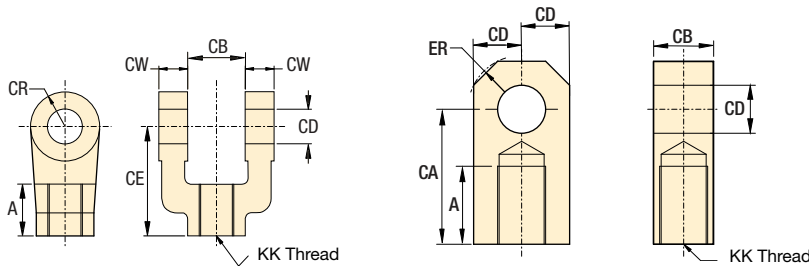

Rod Clevis and Rod Eye dimensions in inches []

| Rod clevis model number | Rod eye model number | Maximum tension load lbs | KK | A | CA | CB | CD | CE | CR | CW | ER | Clevis Pin |
|-------------------------|----------------------|--------------------------|-----------|------|------|------|------|------|------|------|------|----------------|
| TRRC-15 | TRRE-15 | 12,372 | 3/4"-16 | 1.13 | 2.06 | 1.25 | 0.75 | 2.38 | 0.75 | 0.63 | 0.94 | TRPP-15 |
| TRRC-20 | TRRE-20 | 20,433 | 1"-14 | 1.63 | 2.81 | 1.50 | 1.00 | 3.13 | 1.00 | 0.75 | 1.13 | TRPP-20 |
| TRRC-25 | TRRE-25 | 30,483 | 1-1/4"-12 | 2.00 | 3.44 | 2.00 | 1.38 | 4.13 | 1.38 | 1.00 | 1.56 | TRPP-25 |
| TRRC-32 | TRRE-32 | 49,479 | 1-1/2"-12 | 2.25 | 4.00 | 2.50 | 1.75 | 4.50 | 1.63 | 1.25 | 1.88 | TRPP-32 |
| TRRC-40 | TRRE-40 | 70,095 | 1-7/8"-12 | 3.00 | 5.00 | 2.50 | 2.00 | 5.50 | 2.00 | 1.25 | 2.00 | TRPP-40 |

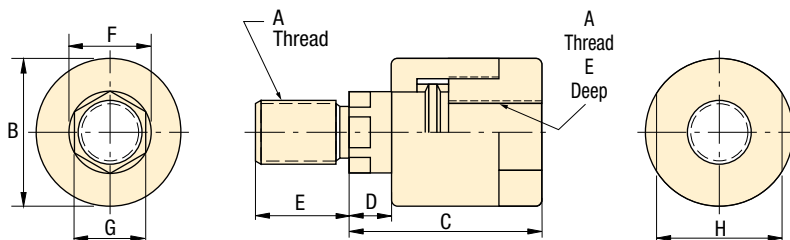

Linear Alignment Coupler in inches []

| Model number | Maximum tension load lbs | A | B | C | D | E | F | G | H |
|----------------|--------------------------|-----------|------|------|------|------|------|------|------|
| TRAC-15 | 8500 | 3/4"-16 | 1.75 | 2.31 | 0.50 | 1.13 | 0.97 | 0.88 | 1.50 |
| TRAC-20 | 16,000 | 1"-14 | 2.50 | 2.94 | 0.50 | 1.63 | 1.38 | 1.16 | 2.25 |
| TRAC-25 | 19,500 | 1-1/4"-12 | 2.50 | 2.94 | 0.50 | 1.63 | 1.38 | 1.16 | 2.25 |
| TRAC-32 | 33,500 | 1-1/2"-12 | 3.25 | 4.38 | 0.81 | 2.25 | 1.75 | 1.50 | 3.00 |
| TRAC-40 | 60,000 | 1-7/8"-12 | 3.75 | 5.44 | 0.88 | 3.00 | 2.00 | 1.88 | 3.50 |